

# PA1200 Applicator

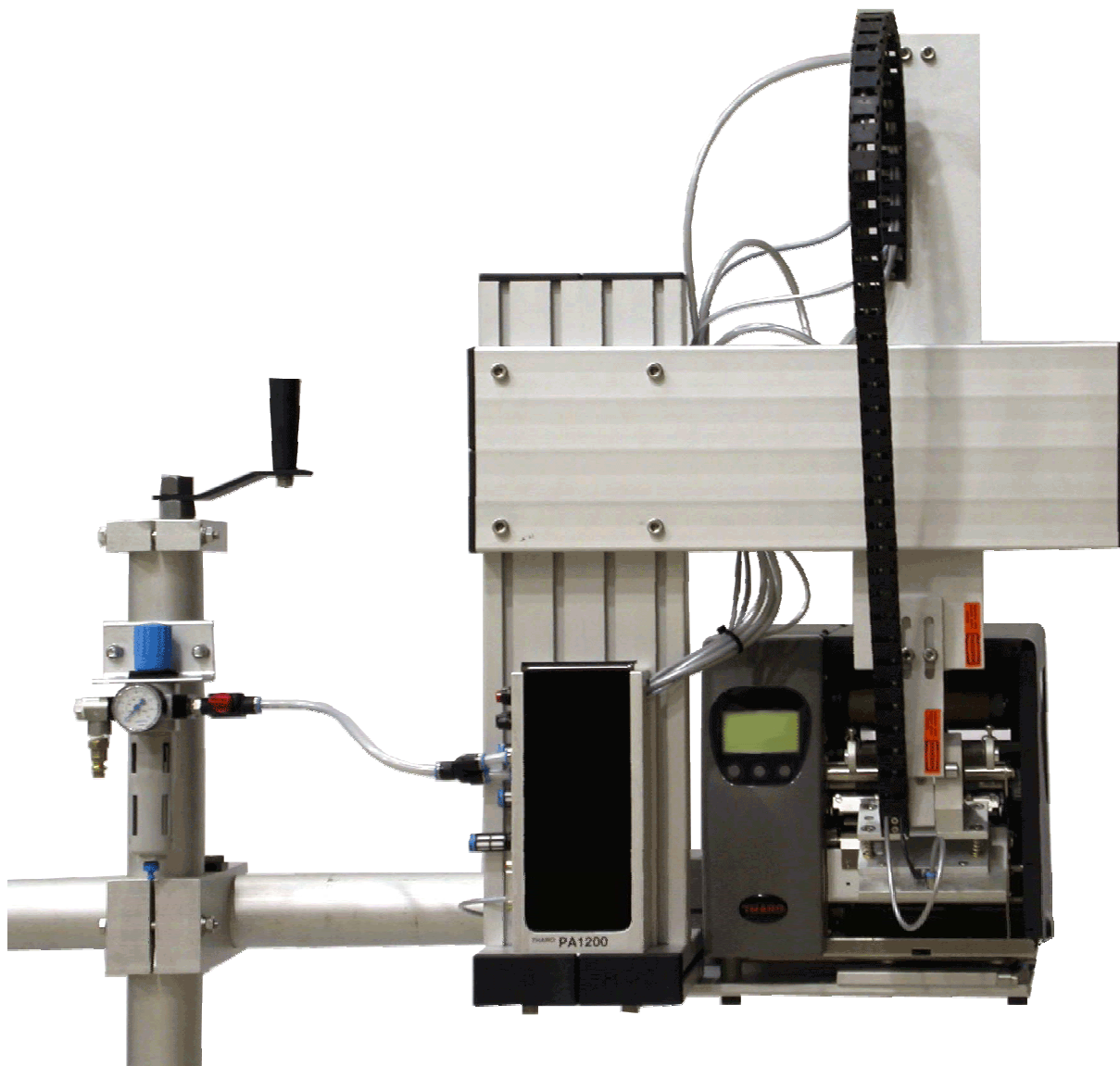

## Operator's Manual

Tharo Systems, Inc.  
2866 Nationwide Parkway  
PO Box 798  
Brunswick, Ohio 44212-0798

Phone: (330) 273-4408  
Fax: (330) 225-0099  
E-mail: [techsupport@tharo.com](mailto:techsupport@tharo.com)  
<http://www.tharo.com>



# TABLE OF CONTENTS

<b>TABLE OF CONTENTS .....</b>	<b>3</b>	<b>OPTIONS AND ACCESSORIES.....</b>	<b>39</b>
<b>PRODUCT DESCRIPTION .....</b>	<b>5</b>	WARNING BEACON .....	39
<b>APPLICATOR SPECIFICATIONS .....</b>	<b>6</b>	PRODUCT SENSOR.....	40
<b>SAFETY INFORMATION .....</b>	<b>7</b>	PRODUCT SENSOR TIMER.....	41
<b>SHIPMENT CONTENTS .....</b>	<b>9</b>	FOOT SWITCH .....	42
<b>QUICK START.....</b>	<b>10</b>	LOCKING CASTERS SET.....	42
<b>H-BASE ASSEMBLY.....</b>	<b>12</b>	LOW PRESSURE SHUTOFF .....	43
<b>T-BASE ASSEMBLY .....</b>	<b>14</b>	EXTERNAL UNWIND/REWIND .....	44
<b>TAMP PAD SETUP.....</b>	<b>16</b>	H-BASE STAND.....	45
<b>APPLICATOR SETUP .....</b>	<b>19</b>	<b>PLC PORT .....</b>	<b>46</b>
<b>PRINTER CONFIGURATION.....</b>	<b>27</b>	PIN ASSIGNMENT .....	46
<b>TAMP ALTERNATIVES .....</b>	<b>28</b>	INPUT DESCRIPTION.....	47
TAMP/BLOW ALTERNATIVE.....	28	OUTPUT DESCRIPTION .....	47
SPECIALTY TAMP ALTERNATIVE .....	28	OUTPUT CAPABILITIES.....	47
<b>TAMP ORIENTATION.....</b>	<b>29</b>	SIGNAL EXPLANATION.....	48
<b>SETUP NOTES .....</b>	<b>33</b>	<b>FIRMWARE .....</b>	<b>53</b>
<b>APPLICATOR OPERATION.....</b>	<b>34</b>	<b>TROUBLESHOOTING .....</b>	<b>54</b>
RESET BUTTON.....	34	CHANGING THE TAMP PAD.....	54
ONESTEP BUTTON.....	34	ADJUSTING THE VACUUM SENSOR .....	55
AIR SUPPLY VALVE .....	35	LABEL SYNCHRONIZATION .....	56
PRINTING AND APPLYING LABELS .....	35	PROBLEM / CAUSE / SOLUTIONS .....	57
LED FUNCTIONS .....	36	SETUP / MEDIA PROBLEMS .....	67
		LED OVERVIEW .....	68
		<b>WARRANTY INFORMATION.....</b>	<b>69</b>



## PRODUCT DESCRIPTION

The PA1200 Tamp Applicator is an accessory designed to automate the label printing and application process. By allowing for height, width and depth adjustments, the PA1200 can accommodate nearly any direct thermal or thermal transfer label printer. The labels are applied with a tamp pad by means of a pneumatic cylinder that moves between the starting position and the labeling position. A switching device, such as a foot switch, optical sensor or PLC (Programmable Logic Controller) can be connected to the applicator's PLC port to initiate and control the print and apply cycle.

Also available, are the specialized tamp and tamp/blow alternatives. The specialized tamp allows for applying very small labels that otherwise could not be applied. The tamp/blow alternative allows labels to be applied to objects that are not flat, such as cylinders, etc. This is accomplished by stopping the tamp before it makes contact with the product, and blowing the label on.

The head mount assembly travels to the dispense edge of the printer where it uses a vacuum to pick up the label. The tamp pad has several holes on the bottom side to allow air to flow and pull the label to it, while a blow bar is used to blow additional air and push the label to the tamp pad.

A vacuum sensor ensures controlled label handling and positioning on the pad. The pad is then moved down into the labeling position, where it triggers the down position sensor. From this position, the pad makes controlled contact with the product and the label is released from the pad. Sensors on the tamp detect the height (or width in side-apply situations) of the product which can vary by as much as 10 inches, and adjusts accordingly to apply the label.

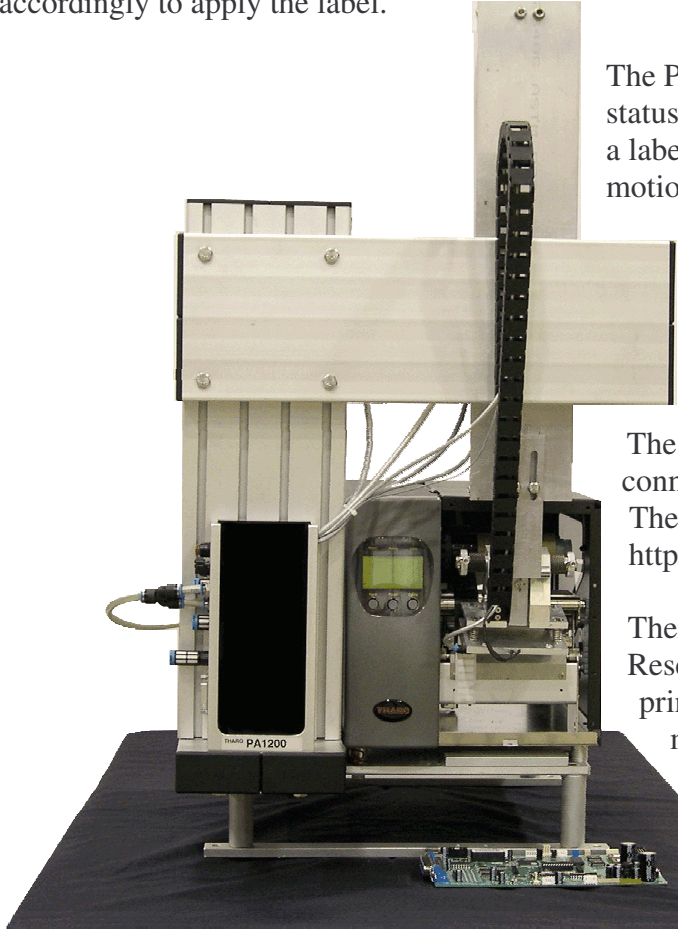

The PA1200 has 2 rows of LEDs which are used to display status and error conditions. If the vacuum sensor does not detect a label on the tamp pad when the cylinder starts its apply motion, or if it detects a vacuum blockage while starting its return motion, an error will be displayed and the apply cycle will pause. Operation will also stop as a result of other printer errors, such as Out of Ribbon or Labels. The LEDs can also be used to display the firmware version in the controller.

The PA1200 applicator's firmware can be upgraded by connecting the applicator controller to the serial port on a PC. The most recent firmware can be downloaded from <http://www.tharo.com>.

There are two buttons on the side of the applicator. The red Reset button serves the same purpose as powering down the printer/applicator. The black One-Step button is used to manually break the print and apply sequence into two separate steps. This will allow for easy re-sequencing of the applicator after a paper out, ribbon out and/or other error conditions.

## APPLICATOR SPECIFICATIONS

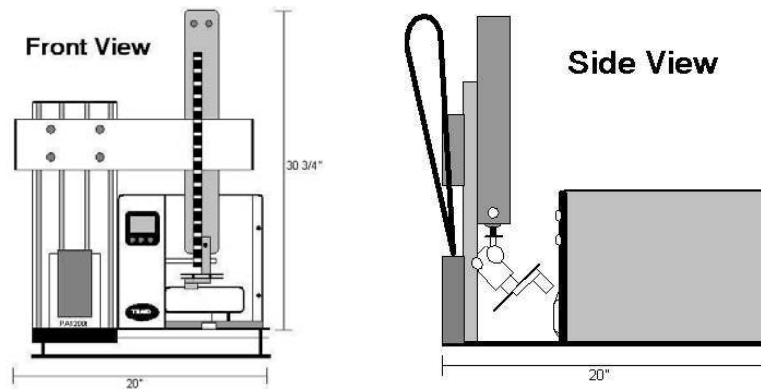

Minimum Size Label:	.20" length x .20" width (5mm x 5mm)
Maximum Size Label:	8.0" length x 4.5" width (203mm x 114mm)
Speed:	Up to 60 labels per minute. Depends on the printer used, height of product, label size, etc.
Label Placement Accuracy:	Capable of label placement accuracy within $\pm 0.01$ " (0.25mm) for stationary products, or $\pm 0.125$ " (3mm) for moving products
Weight:	27 lbs. (12kg)
Weight of Stand:	120 lbs. (55kg)
Tamp Pad Sizes:	4"(101.6mm), 6.5"(165.1mm), 8"(203.2mm), or other custom sizes on an individual basis.
Standard Stroke length:	17" (43mm), 10" (254mm) Below Printer Support Plate. Custom length cylinders are available upon request.
Variable Height:	Pressure Sensors on the tamp head are used to automatically adjust the stroke length to accommodate products of variable height. The pad will stop moving and return to the up position when contact with the product is made. A mechanical adjustment allows for setting the tamp pressure.
Power Source:	Switchable: 100V 60Hz or 230V 50Hz
Printer Type:	Direct Thermal/Thermal Transfer
Air Requirement:	75 to 90 psi (5 to 6 bar)
Environmental:	Temp 50-95°F (10-35°C) at 10-85% humidity
Standards:	Built to CE safety and emissions standards

## SAFETY INFORMATION

### DO:

- **Allow only trained and qualified personnel to perform maintenance, adjustment, and servicing of this unit.**
  - **Keep long hair, loose clothing and jewelry away from moving parts while the unit is in operation.**
  - Observe all printer safety precautions as described in the printer's user manual.
  - Plug the printer into a grounded outlet to reduce the risk of electrical shock!
  - Consider the use of ear protection if prolonged or repeated exposure to the applicator is likely.
  - Install a "Kill Switch" when using this applicator on a conveyor, to stop the conveyor in case a problem occurs.
  - Follow a regular preventative maintenance schedule for cleaning, inspecting and servicing the applicator.
- 

### DO NOT:

- **Attempt to carry out any maintenance, adjustment, or servicing while the equipment is in operation.**
- Plug the printer power cord into the electrical / power unit until all internal cable connections have been properly attached and the installation process has been completed.
- Reach into the area of any moving parts when turning on the air pressure or during operation.
- Use conductive tools on or around the applicator mainboard when the front cover of the applicator is open or removed
- Configure the applicator in an orientation that does not allow the H-base stand to provide adequate support and cause the unit to tip.
- Use this equipment in a manner that is not consistent with the instructions given in this manual.

**Warning! There is a danger of injury with this equipment. Do not reach into the area of any moving parts when turning on the air pressure or during operation.**

Users should consider the use of ear protection if prolonged or repeated exposure is likely.

Due to the weight of the unit, several procedures may actually require two people. (e.g., when adjusting the position of the printer and applicator). It is suggested that safety footwear should be worn when carrying out these tasks.

The printer and applicator must be placed on the H-base stand in a manner that will support the weight of the unit. The printer and applicator should be placed over the legs of the stand. It is suggested that the stand be fastened to the conveyor or work cell. This can help to prevent any vibration, accidental movement or tipping from interrupting normal operation.

Holes have been provided through the H-base stand for mounting the stand directly to the floor, these holes can be used by removing the leveling feet from the H-base stand.

When the cover of the applicator is open or removed, avoid using conductive tools on or around the applicator mainboard to avoid electrical shock and damage to the mainboard!

Replace and close the applicator's cover as soon as possible.

Do not plug the printer power cord into the electrical / power unit until all internal cable connections have been properly attached and the installation process has been completed. Plugging in any of the device cables when electrical power is present can cause damage to the electronics.

Verify that the air service unit and the shut-off valve for the applicator are closed. Make sure that the tamp pad is held in the up position by the air pressure in the pneumatic cylinder.

If the power supply is interrupted, the pad will immediately return to the up position.



## SHIPMENT CONTENTS

### BOX 1 Contents

Short (32") rectangular bar with base clamp  
2x Long (36") rectangular bar

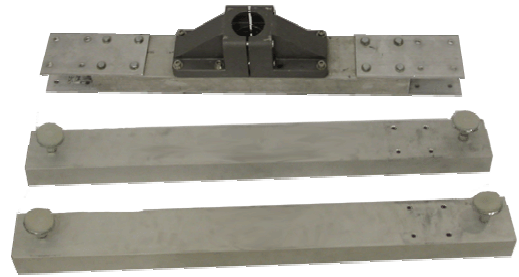

### BOX 2 Contents

Short (36") round bar (yardarm)  
Long (54") round bar with hand crank (mast) **OR**  
Long (54") standard round bar (mast)  
Printer support plate clamp

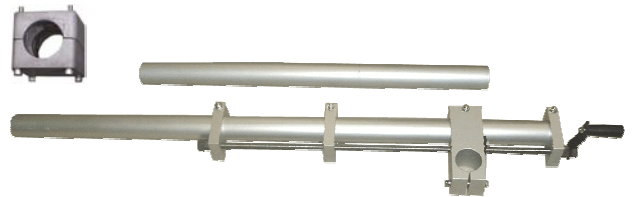

### BOX 3 Contents

Printer support plate

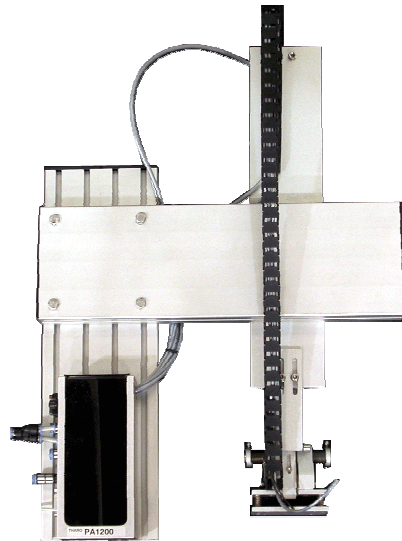

### BOX 4 Contents

Applicator



### BOX 5 Contents

Tharo H-Series printer with applicable accessories  
*(Please refer to the shipment contents checklist in the "Printers Operators Manual")*



### BOX 6 Contents

Tamp pad  
Regulator  
Core adapter  
Regulator hose  
Operator's Manual on CD  
Ferrite core  
Applicator Support Plate



## QUICK START

The PA1200 Tamp Applicator is easy to assemble and use. The following is a summary of the necessary steps to get the applicator up and running.

Please read the entire manual for more detailed instructions and tips for trouble-free assembly.

1. H-base Stand
  - Unpack the applicator's H-base stand.
  - Assemble the H-base stand.
  
2. Printer
  - Unpack the printer.
  - Secure the printer to the support plate
  
3. Applicator
  - Mount the applicator support plate to the printer support plate.
  - Mount the applicator to the applicator support plate.
  - Using the supplied cable, connect the applicator to the internal port on the printer.
  - Punch holes in the pad for the correct label size.
  - Attach the pad to the applicator.
  
4. Install Trigger Device (sensor, foot switch or PLC)
  - Plug in the optical sensor, foot switch or PLC that will be triggering the applicator
  - Install the triggering device
  
5. Load Media
  - Load label stock in printer
  - Load ribbon in printer
  
6. Apply Air
  - Attach the regulator to the H-base stand
  - Connect the support air line to the blow bar
  - Connect the regulator to the applicator
  - Apply your supply air to the regulator
  - Set to between 5 and 6 bar

**WARNING!** When air is being applied, keep fingers and hands away from moving parts.

7. Apply Power
  - Snap ferrite core onto printer power cord
  - Attach power cord to the printer
  - Plug power cord into a grounded outlet
  
8. Configure Printer
  - Set the printer to “Applicator” Mode
  
9. Send Label Job to Printer
  - Download a job to the memory card or send a print job to the printer
  - Select a job from the memory card if the printer is in stand-alone mode
  
10. Print and Apply Cycle
  - When the printer front panel displays the number of labels to be printed (i.e.- 00001), the system is ready to be triggered by a start signal. Turn on the conveyor or place the product in the work cell and test the operation. If using the PA1200 with a conveyor, adjust the triggering device as necessary to place the label in the desired position on the product.

## H-BASE ASSEMBLY

### Tools required for H-Base assembly:

- 6mm Allen Wrench
- 13mm Combination Wrench

### Setup:

1. Remove the 4 bolts from each of the 2 ends on the center bar with the base clamp.

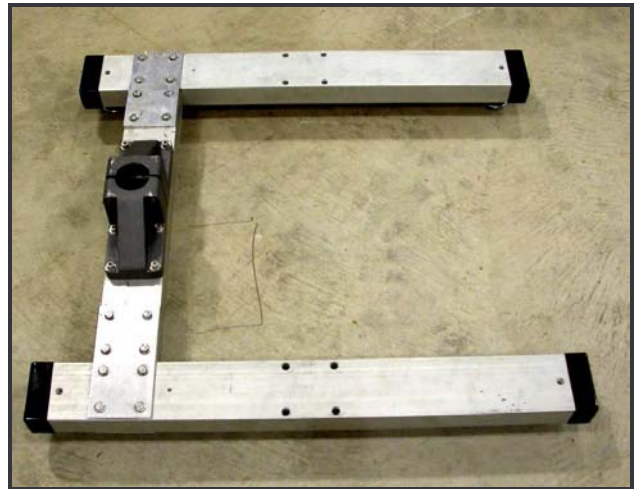
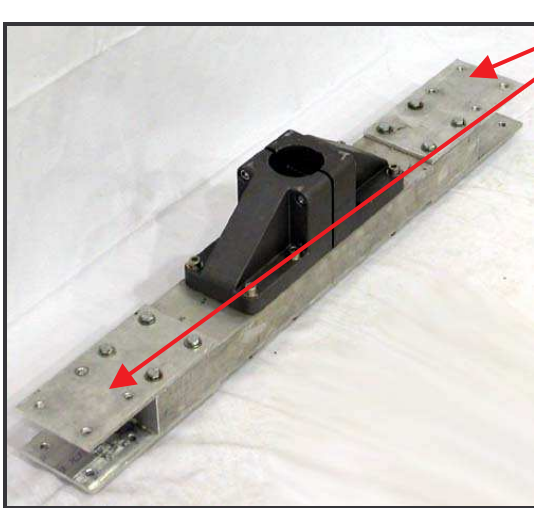

2. Insert the 2 legs into the openings on the ends of the center bar and tighten all 8 bolts securely.
3. Remove the 2 bolts from the bottom of the base clamp, nearest the allen heads of the bolts on the vertical side of the base clamp.

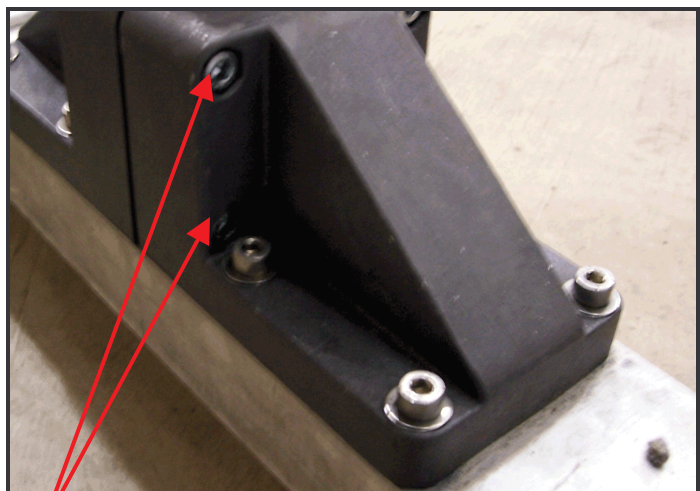
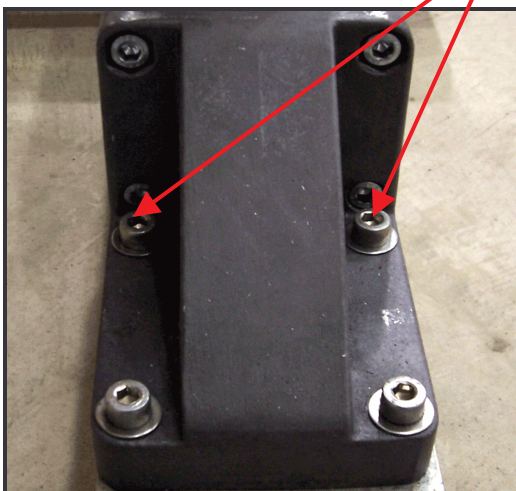

4. With a 6mm allen wrench, loosen the 4 bolts in the vertical side of the base clamp to allow mast insertion.

5. Insert the mast into the opening in the base clamp. Be sure to align the cross clamp parallel to the legs.
6. Tighten the 4 bolts evenly to secure the mast in the base clamp.
7. Replace and tighten the 2 bolts removed from the bottom of the base clamp.
8. Insert the yardarm into the cross clamp and tighten securely.
9. Remove the 4 bolts from the printer support plate clamp.

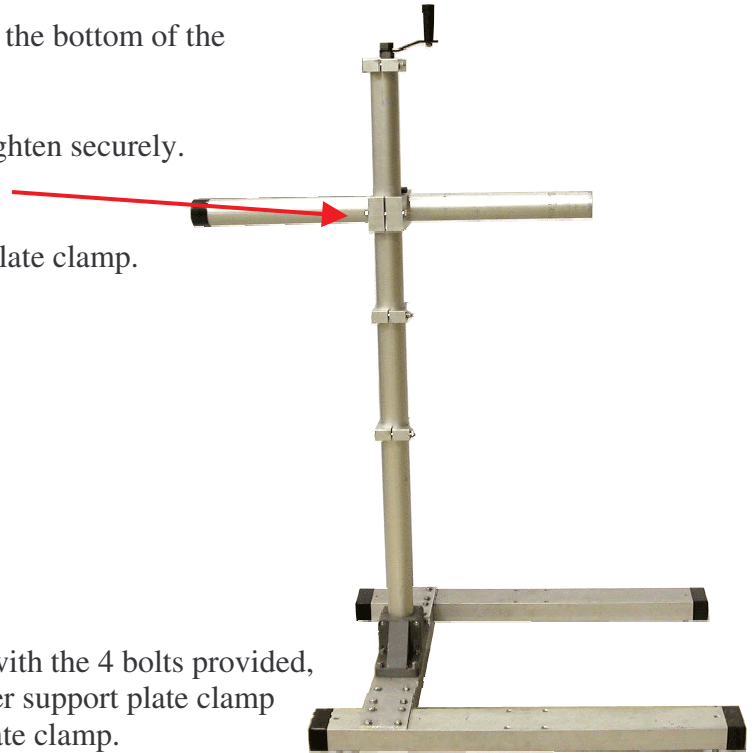
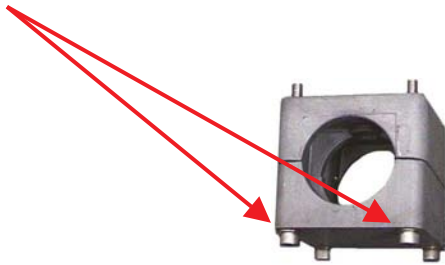

10. Attach the clamp to the printer support plate with the 4 bolts provided, but DO NOT tighten. The nuts for the 4 printer support plate clamp bolts sit in the recess in the printer support plate clamp.

**Important Note:** The orientation of the printer support plate clamp on the support plate will vary depending on application. Please see TAMP ORIENTATION before continuing.

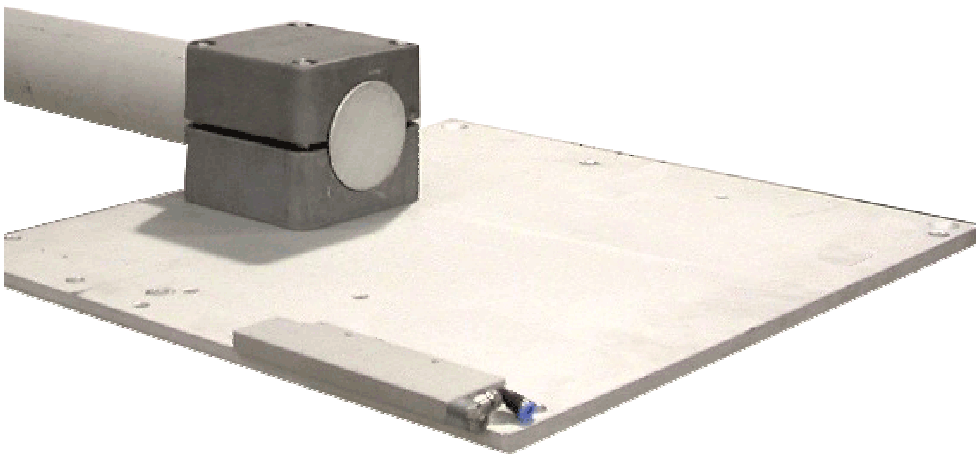

11. Slide the printer support plate with the clamp attached onto the yardarm and tighten the 4 bolts evenly.

## T-BASE ASSEMBLY

### Tools required for H-Base assembly:

- 6mm Allen Wrench

### Setup:

1. Remove the 4 bolts from the open end of the short bar with the base clamp.

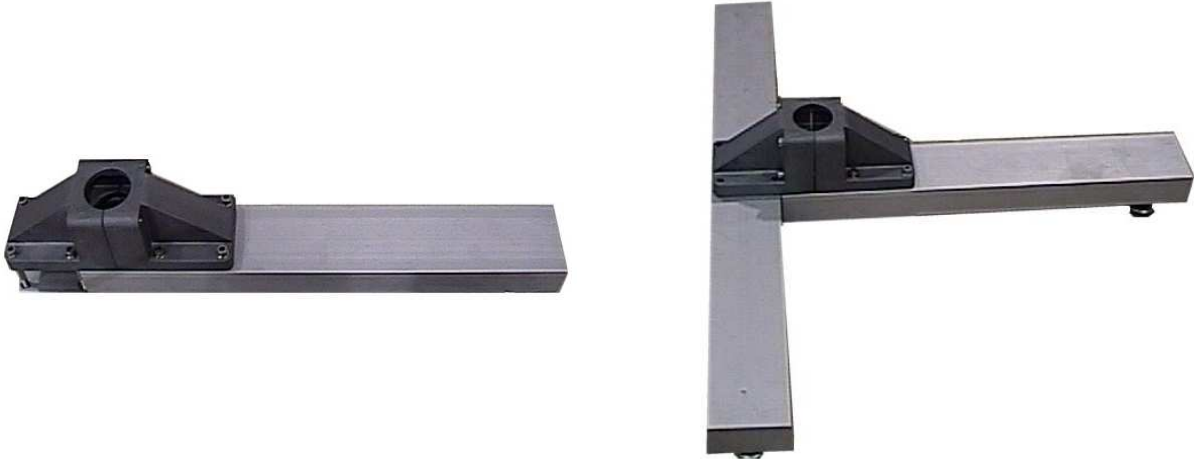

2. Insert the long bar into the opening in the short bar.

3. Remove the 2 bolts from the bottom of the base clamp, nearest the allen heads of the bolts on the vertical side of the base clamp.

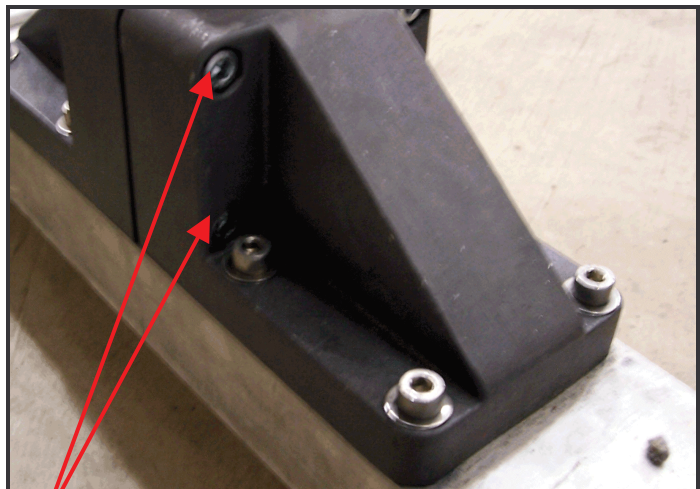
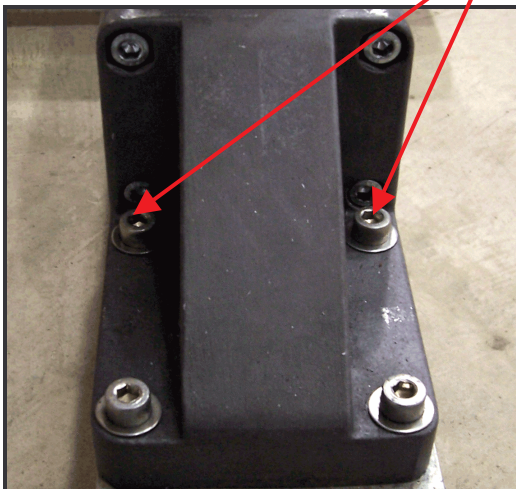

4. With a 6mm allen wrench, loosen the 4 bolts in the vertical side of the base clamp to allow mast insertion.

5. Insert the mast into the opening in the base clamp. Be sure to align the cross clamp parallel to the short leg.
6. Tighten the 4 bolts evenly to secure the mast in the base clamp.
7. Replace and tighten the 2 bolts removed from the bottom of the base clamp.
8. Insert the yardarm into the cross clamp and tighten securely.
9. Remove the 4 bolts from the printer support plate clamp.

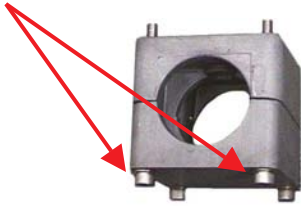

10. Attach the clamp to the printer support plate with 4 bolts but DO NOT tighten. The nuts for the 4 printer support plate clamp bolts sit in the recess in the printer support plate clamp.

**Important Note:** *The orientation of the printer support plate clamp on the support plate will vary depending on application. Please see TAMP ORIENTATION before continuing.*

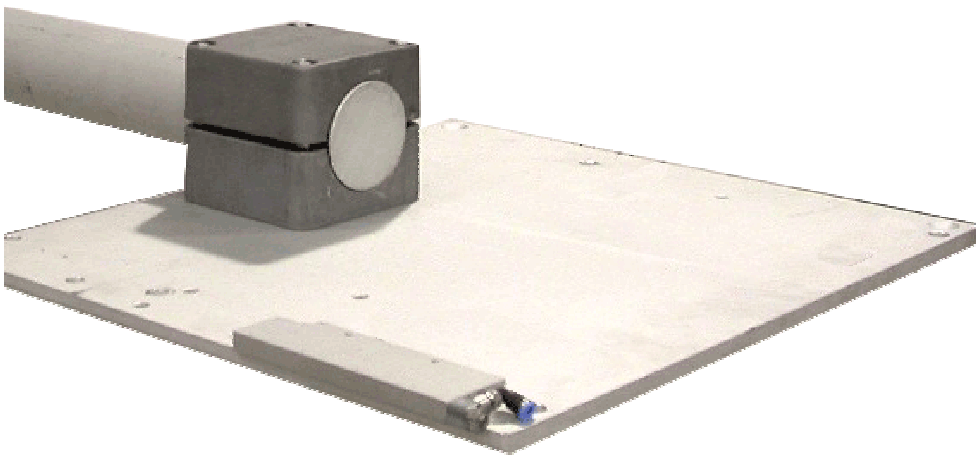

11. Slide the printer support plate with clamp attached onto the yardarm and tighten the 4 bolts evenly.



## TAMP PAD SETUP

The customizable tamp pad comes pre-fitted with a nonstick plastic surface that can be made to fit your label size. This is accomplished by using the included hole punch and by piercing holes in the pad at the channel in the correct area that corresponds to your label size.

Care should be taken when handling the pad to prevent damage or separation of the plastic from the pad, which could cause a poor vacuum seal and not allow the applicator to function properly.

**Do not punch holes exactly on the edge of the label or in any area that will not be covered by the label, otherwise the pad will not work!**

Before punching the holes in the pad within the channel, place the pad on the applicator and line up the screw holes with the holes on the lower spring plate. The corner closest to the printer and applicator is the 0,0 point.

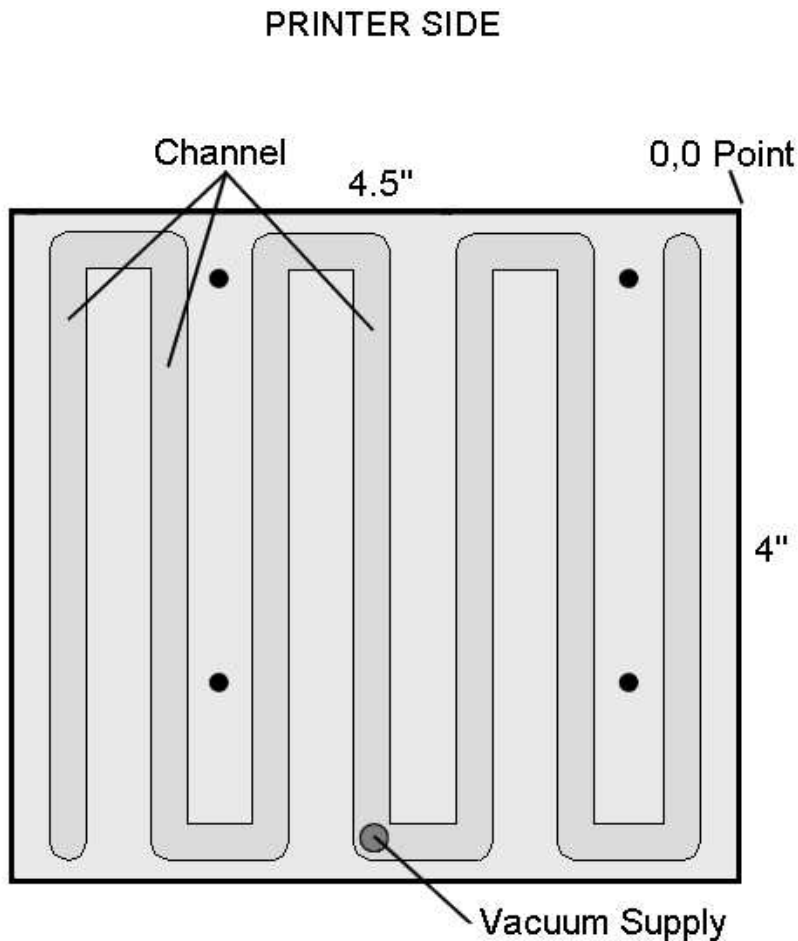



**To correctly punch your pad:**

1. Begin by placing the pad plastic side up, as shown.
2. Place your label onto the pad, making sure that the corner of the label is at the 0,0 point. From the **PRINTER SIDE** edge of the pad, measure down the length of the label **4mm**. Then measure **9mm** inwards from the **APPLICATOR SIDE** edge.

Punch a hole at this point within the center of the channel.

3. Make sure that the piece of pad that is punched out is removed from the pad. If it is not, it may clog the vacuum.

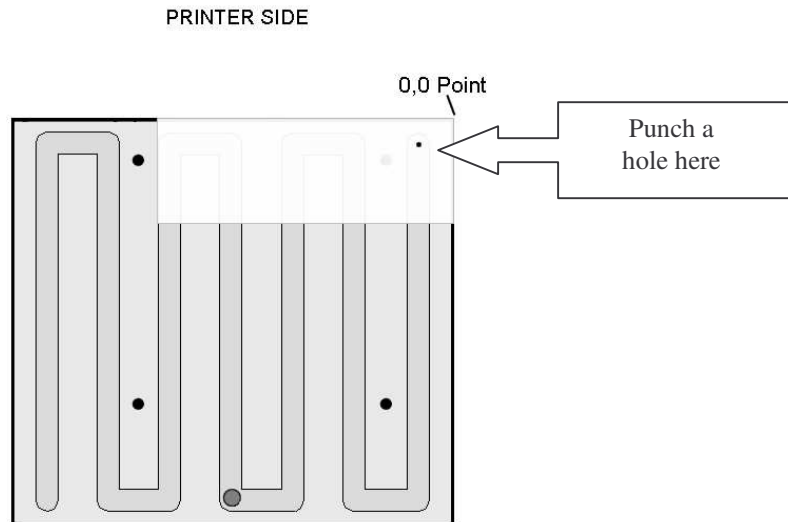

4. Measure down the left edge of the label **4mm** and punch a hole within the center of the channel, making sure that the hole is not on the edge of the label. If it is on the edge, move further inwards to the next channel and punch a hole **4 mm** down from the Printer Side of the pad.

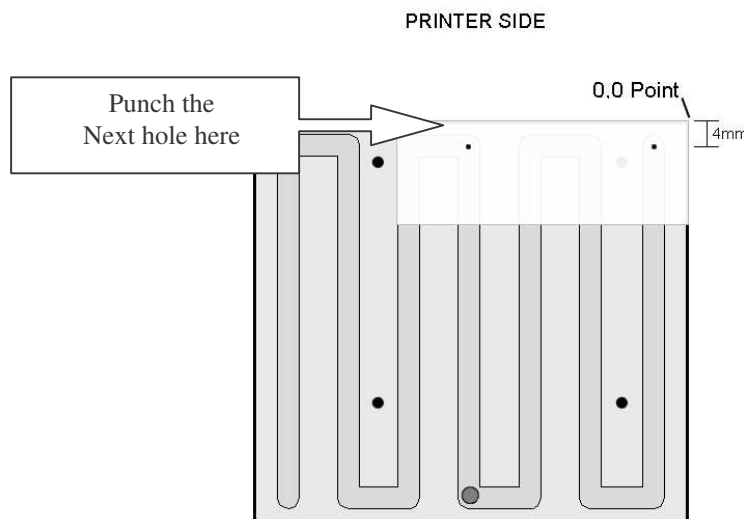

Now punch a hole in every channel between these two points.

5. Measure **11mm** in from the leading edge of the label (the edge closest to you at this point) and punch holes in every channel. Make sure that any hole that might be on the edge of the label is moved into the next channel within your label.

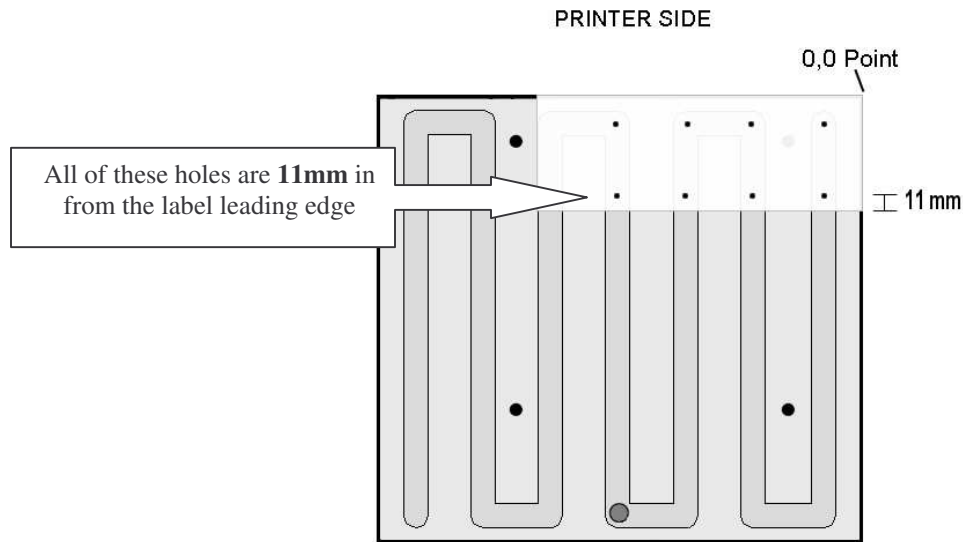

This pad is properly punched for a 3" x 1" label.

**NOTE:** A hole must be punched in every channel across the leading and trailing edge of the pad within the labels width.

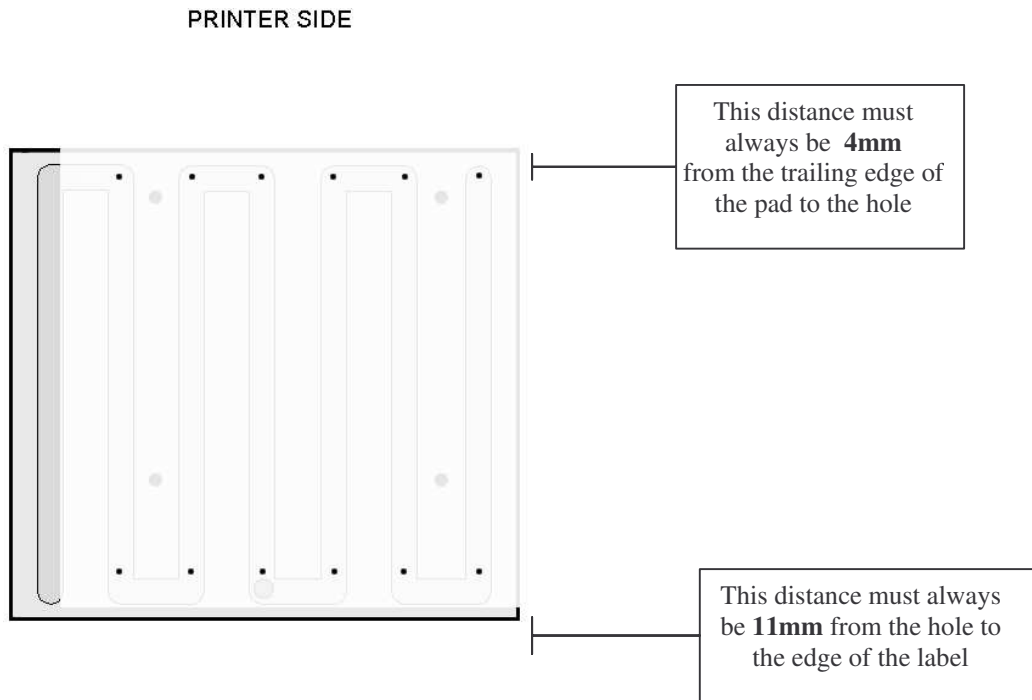

This pad is properly punched for a 4" x 4" label.

## APPLICATOR SETUP

### Tools required for Applicator Setup:

- 2.5mm Allen Wrench
- 5 mm Allen Wrench
- 6 mm Allen Wrench
- 8 mm Allen Wrench
- Flat-Head Screwdriver (optional)

### Setup:

1. Remove the front cover of the printer.



2. Attach the printer's legs to the printer support plate using the 4 bolts provided and an 8mm allen wrench.

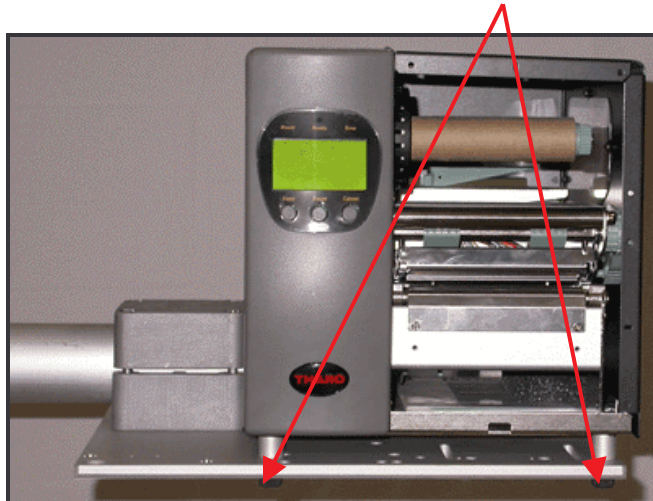

3. Mount the applicator to the applicator support plate using the four (4) supplied bolts, and a 6mm allen wrench.
4. Mount the applicator support plate to the printer support plate using the two (2) supplied bolts and adjust the depth according to the printer. Be sure to tighten the bolts securely.

**Note:** In order to prevent injury, 2 people are required for this step.



5. Use a 6mm allen wrench to loosen the 4 bolts on the front of the applicator and adjust the height, so the tamp pad aligns with the peel edge. Be sure to re-tighten the bolts securely



Loosen these bolts

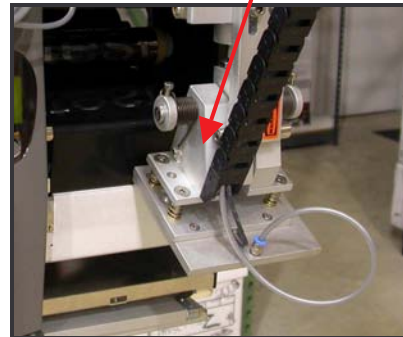

The tamp should be vertically aligned with the peel edge of the printer.

6. Use a 6mm allen wrench to loosen the 4 bolts on the back of the applicator arm to adjust the width. Center the tamp pad over the labels. Be sure to re-tighten the bolts securely.



Loosen these bolts

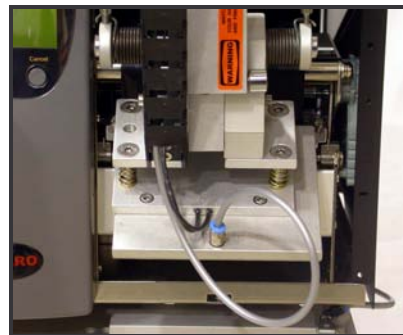

The tamp pad should be aligned with the peel edge.

7. Connect the applicator's printer connection cable to the printer's internal peripheral port.

**NOTE:**

*Be sure that all power is disconnected before connecting the cable to the printer.*



8. Remove the 4 screws from the top of the tamp pad.



9. Gently lower the applicator arm.

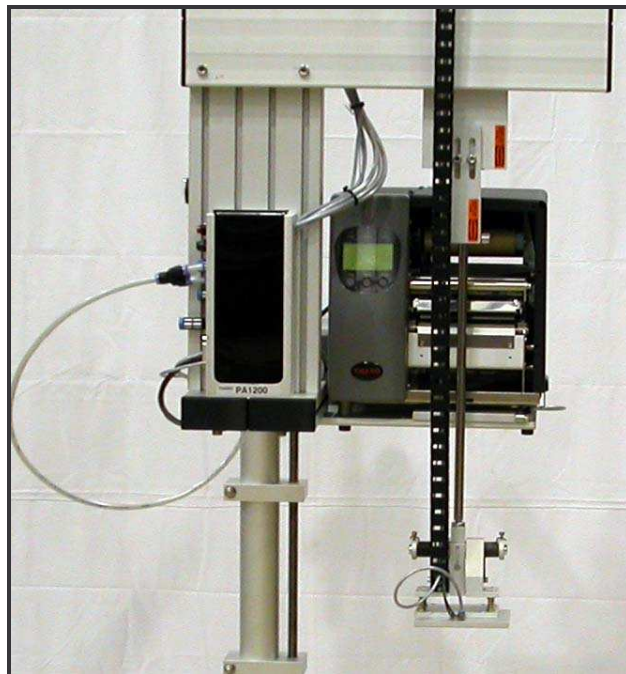

10. Mount the tamp pad to the lower spring plate of the applicator arm with the 4 screws removed from the tamp pad.

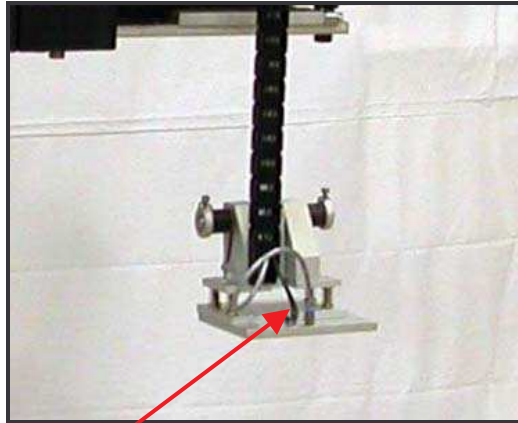

11. Slide the vacuum line coming from the applicator arm into the quick connect fitting on the tamp pad.
12. Attach the air regulator to the main mast by removing the U-bolt bracket and placing it around the main mast. Once the bracket is placed in the desired position, tighten the 2 nuts.



13. Slide one end of the regulator hose into the quick connect fitting on the applicator.

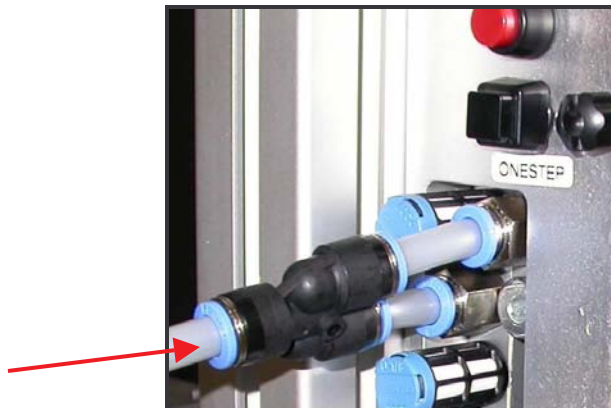

14. Slide the other end of the hose into the quick connect fitting on the regulator.



15. Insert the open end of the support air line into the quick connect fitting on the blow bar.

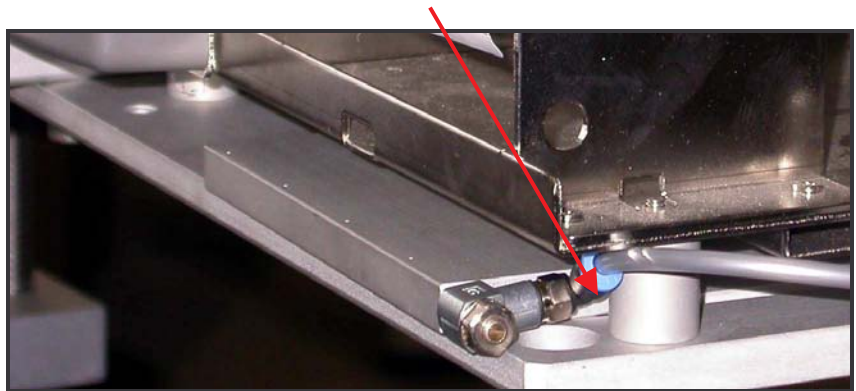
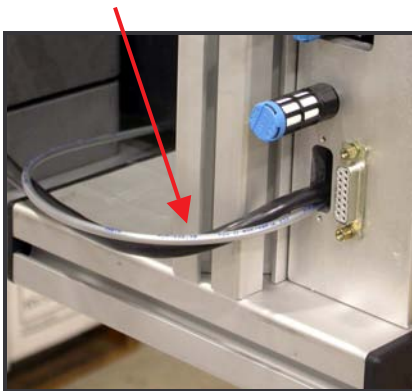

16. Adjust the tamp head angle by loosening the 2 bolts and sliding the bar up or down. Slide the bar lower to increase the angle of the tamp head, or higher to decrease the angle. For a Standard tamp pad, in the Up position, the tamp pad should be centered over the peel edge between 2 and 4mm above the peel edge and 0 to 4mm in front of the peel edge. For the Specialty tamp, in the Up position, the tamp should be centered over the label 1mm above and 1mm behind the peel edge.

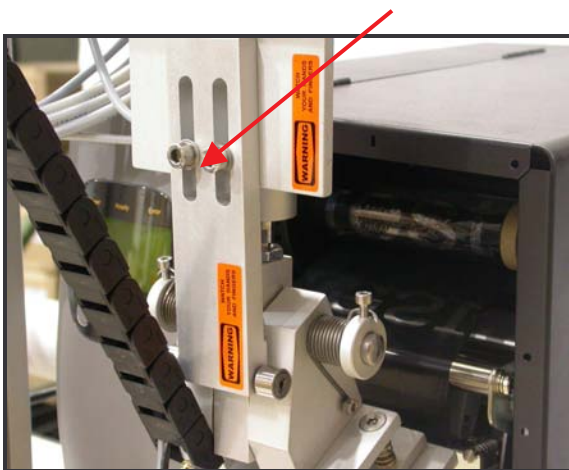

Loosen these bolts to adjust the angle.



The tamp pad should be aligned with the peel edge.

17. Adjust the tamp angle. The tamp pad should come into contact with the product as flatly as possible.

This can be accomplished by turning off the supply air and manually moving the pad onto the product (simulate the apply as closely as possible). Adjust the applicator by moving the whole stand or by loosening the yardarm side of the cross clamp attached to the mast. Rotate the yardarm as needed to compensate for any angle between the pad and the product.

**Caution! When loosening the cross clamp, always have a second person hold the printer and applicator securely in place so that it cannot fall or tip in order to prevent personal injury and equipment damage.**

Please note that the pad is designed to flex to the angle of the product. This particular feature is intended to compensate for the occasional uneven product. This pad has not been designed to withstand constant flexing if the maximum life is desired from the applicator. Therefore, the pad should be aligned as flatly as possible with the product.

18. Attach the air supply to the input on the regulator, and set to between 5 and 6 bar.





19. Adjust the speed of the Down and Up stroke if necessary.

The speed of the down stroke and up stroke are factory set. However, some applications may require adjustment. Use a small flat-head screwdriver to adjust the following settings:

### Down stroke speed

Turn this valve counter-clockwise to increase speed, or clockwise to decrease speed.



### Up stroke speed

Turn this valve counter-clockwise to increase speed, or turn it clockwise to decrease speed.

## 20. Adjust Tamp Pressure

The tamp pressure is set by an adjustment located on the tamp head. This is factory set and adjustments in the field should not be necessary.

To increase the tamp pressure, loosen the 2.5mm bolt and move the slide up.

To decrease the tamp pressure, loosen the 2.5mm bolt and move the slide down.

Retighten the bolt. Make sure to tighten the bolt enough to prevent the slide from moving during use.

Note that the tamp pressure is also effected by the cylinder, stroke speed and the applicator orientation. When changes are made to the stroke speed or orientation, the tamp pressure may need to be adjusted. It is best to set the tamp pressure to a point in which the pad gently touches the product. Excessive tamp pressure will cause unnecessary stress and wear of the applicator.

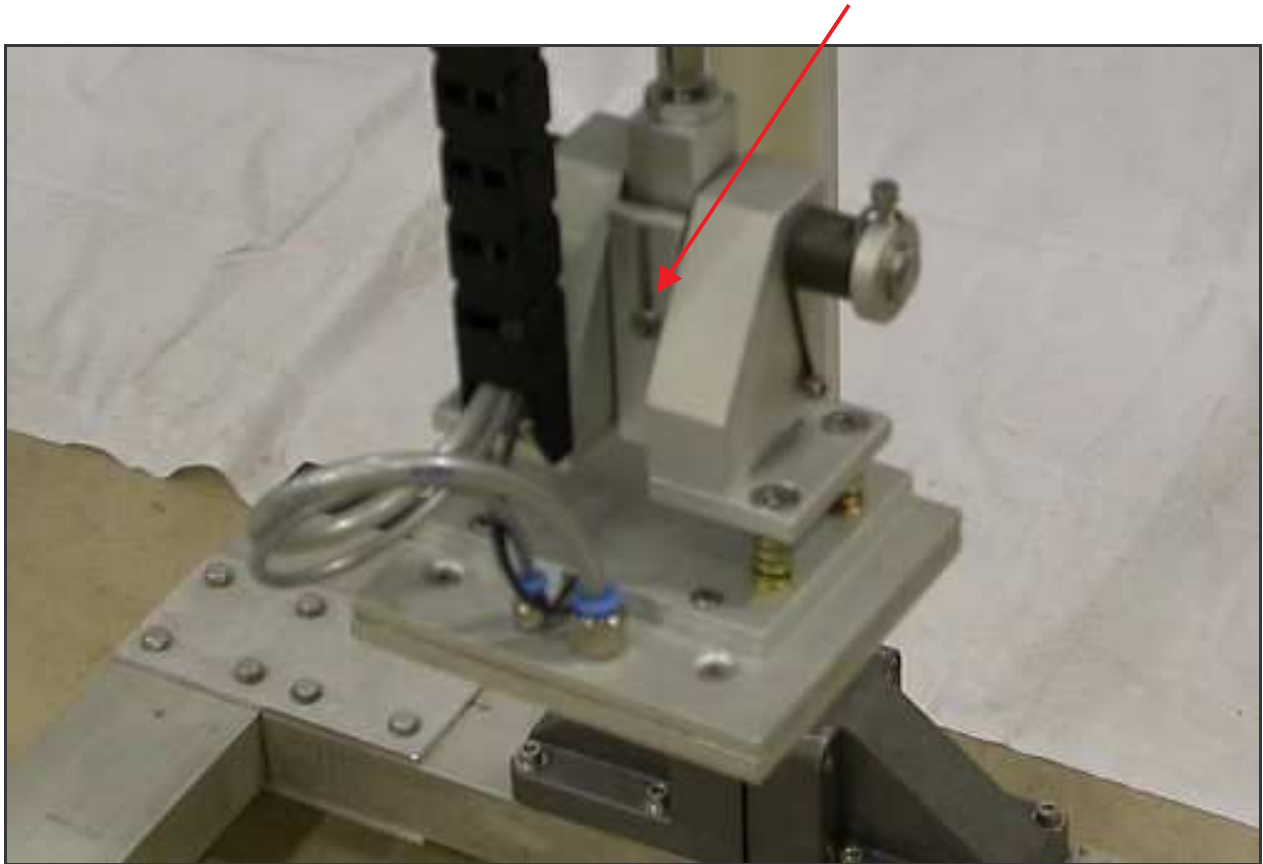

## PRINTER CONFIGURATION

Before applying power to the printer, be sure to snap the ferrite core onto the printer power cord. This device will help reduce the chances of malfunction and failure of the printer and applicator when there is electrical noise in the power, which is common in manufacturing environments.

To prevent the risk of electrical shock, and to help reduce the effect of electrical noise, EMI, EMC, and ESD, always plug the printer into a grounded outlet.

The printer must be configured through its front panel in order for the applicator to work correctly.



To enter the printer configuration on the Tharo H-Series printers, press and hold the “**Pause**” key and the “**Feed**” key until the LCD shows “**Setting Mode**”. Once in Setting Mode, the 3 buttons have the following functions:

- Feed key:** Select or scroll through the available selections
- Pause key:** Enter or Confirm
- Cancel key:** Exit

Use the “**Feed**” key to scroll to “**Option Setup**” and press “**Pause**” to select. Use the “**Feed**” key to scroll to “**Applicator Mode**” and confirm with the “**Pause**” key. To exit the menu, press the “**Cancel**” key twice, followed by the “**Pause**” key.

*Please refer to the printer manual for more detailed instructions on printer configuration.*

If the Smart Backfeed setting is enabled, you may see a white line running across the label if there are fields near the bottom of the label. If used in conjunction with a conveyor, the Smart Backfeed setting may cause the first and second label printed, to be applied in a different place than the rest of the labels in the job.

Load the labels and ribbon in the printer.

*Please refer to the printer manual for more detailed instructions on loading media.*

**Note:** *To cancel a print job with Smart Backfeed enabled, the OneStep button must be held in while pressing the Cancel button followed by the Reset button.*

## TAMP ALTERNATIVES

### Tamp/Blow Alternative

There are 3 additional steps to setup the PA1200tb:

1. Connect the air hose to the tamp pad. The PA1200tb uses a different tamp pad than the PA1200t that stops between ½” and 2” from the product and blows the label on. This requires a second air hose to be connected to the tamp pad.

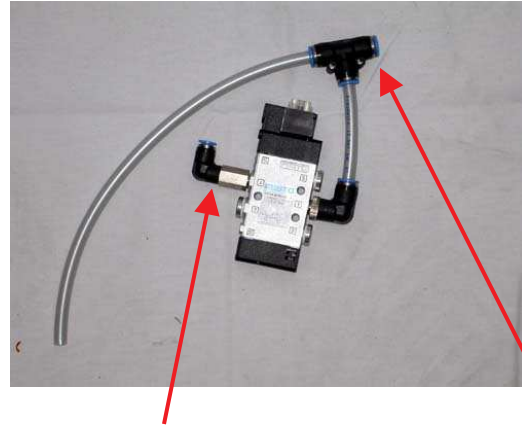
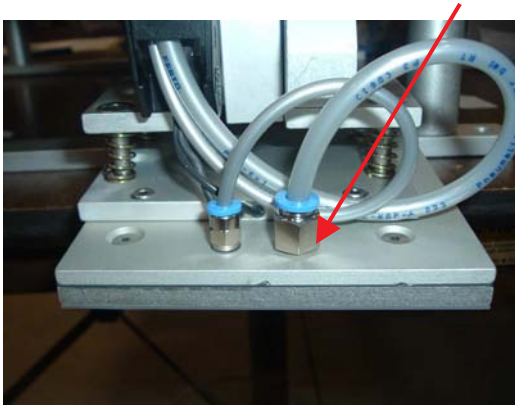

2. The blow valve is fastened to the back of the applicator, and has a small quick-connect fitting, and a T-connector with 2 large quick-connect fittings. Connect the supply air to one side of the T-connector, and the applicator's air input hose to the other end of the T. Connect the small air hose from the applicator to the quick-connect fitting on the blow valve.
3. Since the pad never comes in contact with the product, the down position must be determined. This is adjusted by loosening the bolt and set screw with a 2mm and 3mm allen wrench, and sliding the sensor up or down the cylinder. Be sure to re-tighten the screw to prevent the sensor from sliding down the cylinder.

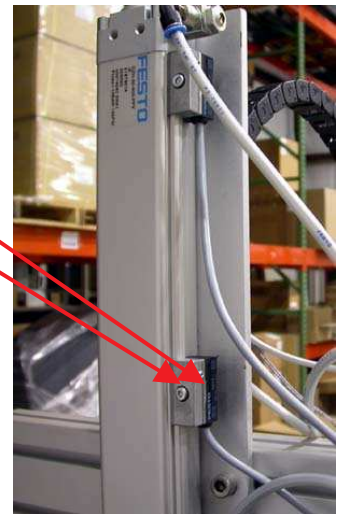

### Specialty Tamp Alternative



For situations where very small labels need to be applied such as circuit board applications, the PA1200 will permit labels as small as .20” wide x .20” high.

The Specialty Tamp is installed by fastening the tamp pad to the lower tamp plate with the 2 provided screws.

The air regulator should be set to 4 ½ bar.

## TAMP ORIENTATION

The PA1200 can apply labels in the following four orientations:

### 1. Top apply with the applicator parallel to conveyor or work cell



(applicator in upright position)

In order to configure the applicator for this type of application, place the clamp on the printer support plate with the opening facing towards the printer. Attach the printer support plate to the yardarm with the printer in an upright position. Be sure to slide the yardarm completely into the clamp before tightening.

To prevent the stand from tipping, it is best to keep the printer and applicator as close to the mast of the stand as possible. Adjustments can be made by loosening the yardarm side of the cross clamp attached to the mast and sliding the yardarm. If necessary, you can remove the leveling feet from the stand, slide bolts through the holes in the stand, and bolt the stand directly to the floor.

**2. Top apply with the applicator perpendicular to the conveyor or work cell**



(applicator in upright position)

In order to configure the applicator for this type of application, place the clamp on the printer support plate with the opening parallel to the printer. Attach the printer support plate to the yardarm with the printer in an upright position. Be sure to slide the yardarm completely into the clamp before tightening.

To prevent the stand from tipping, it is best to keep the printer and applicator as close to the mast of the stand as possible. Adjustments can be made by loosening the yardarm side of the cross clamp attached to the mast and sliding the yardarm. If necessary, you can remove the leveling feet from the stand, slide bolts through the holes in the stand, and bolt the stand directly to the floor.

### 3. Side apply with the printer on its rear

In order to configure the applicator for this type of application, place the clamp on the printer support plate with the opening facing the printer. Attach the printer support plate to the yardarm with the printer on its rear. Be sure to slide the yardarm completely into the clamp before tightening.

To prevent the stand from tipping, it is best to keep the printer and applicator as close to the mast of the stand as possible. Adjustments can be made by loosening the yardarm side of the cross clamp attached to the mast and sliding the yardarm. If necessary, you can remove the leveling feet from the stand, slide bolts through the holes in the stand, and bolt the stand directly to the floor.



When using the applicator in this orientation, the core adapter must be attached to the label supply shaft on the printer. This will prevent the label supply roll from hanging up or dragging on components inside the printer. The core adapter should be installed as illustrated below:

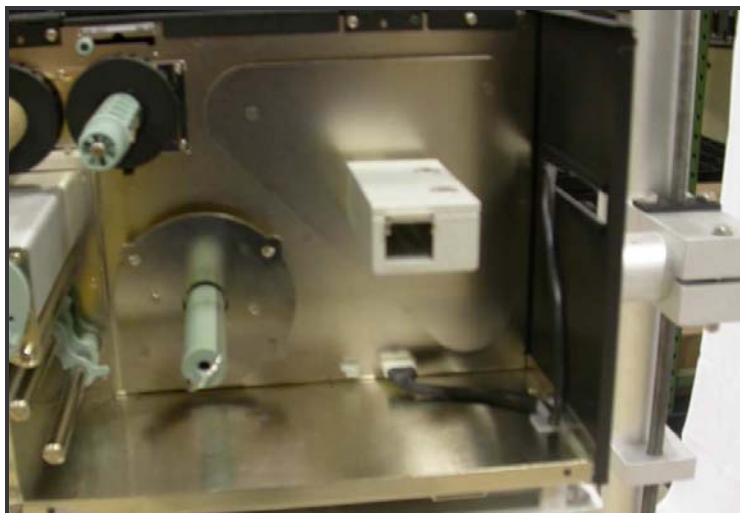

#### 4. Side apply with printer on it's side

In order to configure the applicator for this type of application, place the clamp on the printer support plate with the opening parallel to the printer. Attach the printer support plate to the yardarm with the printer on its side, and with the back of the printer facing toward the mast. Be sure to slide the yardarm completely into the clamp before tightening.

To prevent the stand from tipping, it is best to keep the printer and applicator as close to the mast of the stand as possible. Adjustments can be made by loosening the yardarm side of the cross clamp attached to the mast and sliding the yardarm. If necessary, you can remove the leveling feet from the stand, slide bolts through the holes in the stand, and bolt the stand directly to the floor.



When using the applicator in this orientation, the core adapter must be attached to the label supply shaft of the printer. This will prevent the label supply roll from hanging up or dragging on components inside the printer. The core adapter should be installed as illustrated below:

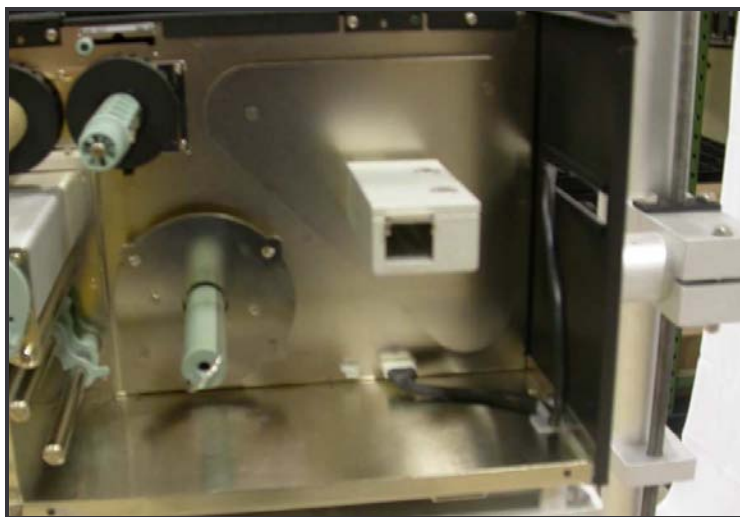



## SETUP NOTES

The following is a list of factors to consider when using an optical sensor with the applicator on a conveyor:

The second box (or product) back should not trip the optical sensor until the pad has returned to the *up* position. If this occurs, the label placement will be delayed and cause the label to be positioned too far back or off the back of the box. The applicator will not begin the print and apply cycle until the sensor has been reset and then triggered again by another box.

**If the label is too far back on the box or product**, move the sensor away from the applicator. This will cause the box to trip the sensor sooner, which allows the applicator more time to put the label on the box. The label will then be applied sooner, and therefore closer, to the front of the box or product.

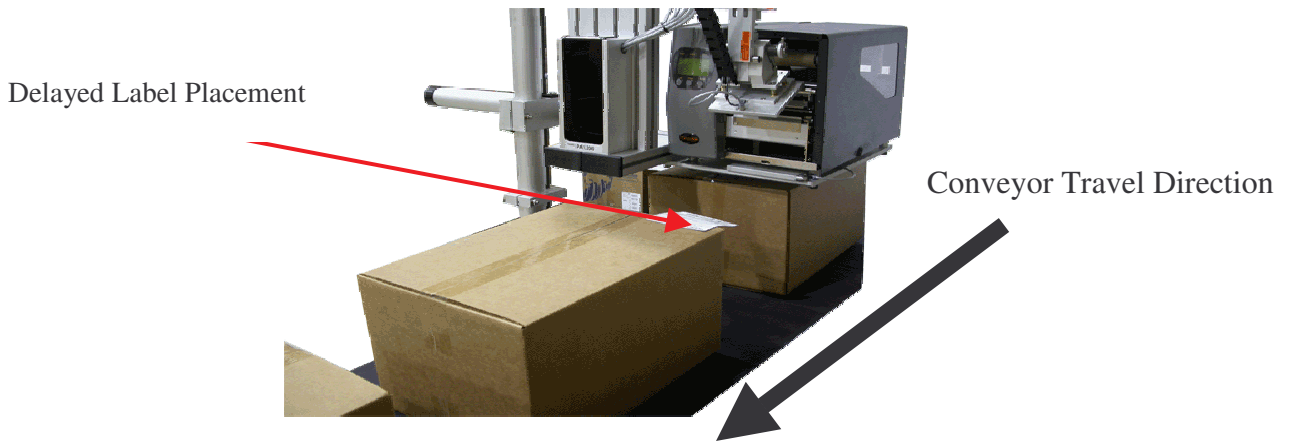

**If the label is too far forward on the box or product**, move the sensor toward the applicator. This will cause the box to trip the sensor later, which allows the applicator less time to put the label on the box. The label will then be applied later, and therefore further, towards the back of the box or product.

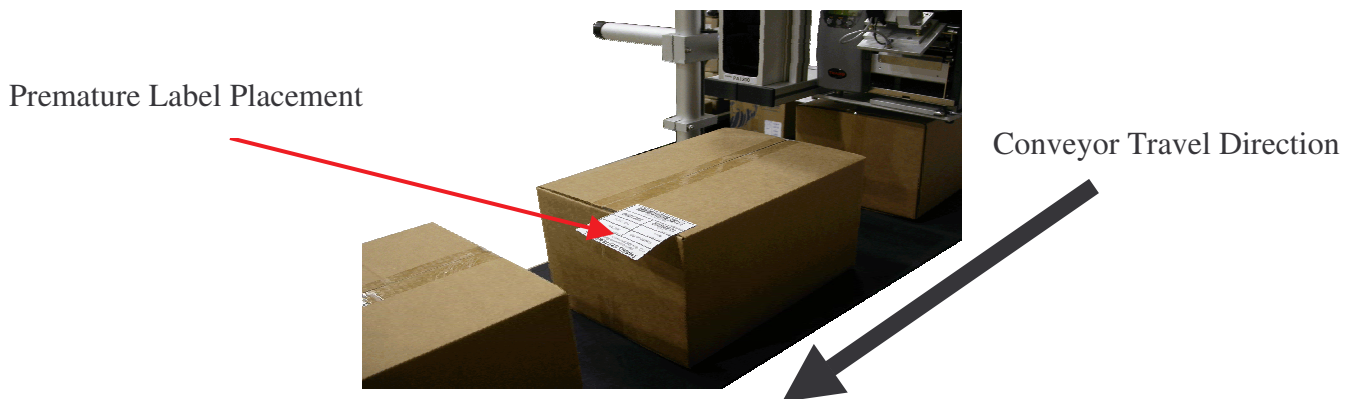

The optional timer can also be used to adjust the placement of the label. A preset delay in the timer can delay the *start* signal. This feature can be used to adjust the label placement in a more precise manner. It may be useful in applications where the sensor mounting position is limited and does not allow the sensor to be moved in order to adjust label placement.

The conveyor speed must remain constant for the label placement to be consistent. If the conveyor speed fluctuates, the label placement will also fluctuate.

## APPLICATOR OPERATION

### Reset button

The *Reset* button is a round, red button located on the top left side of the unit, and serves dual purposes: (1) To reset an applicator error, and (2) To stop operation of the applicator at any time.

If an applicator error occurs, a status message is displayed using the LEDs, and operation is halted. The *Reset* button is used to clear the error condition. Once the button is released, the applicator resets itself and performs a vacuum test, which is audible as two quick bursts of air. Provided there are no more error conditions, such as a vacuum blockage, the applicator is ready to resume normal operation.

Holding down the *Reset* button will immediately halt the applicator. The *Stop* condition is maintained as long as the button is pressed. Once the button is released, the applicator will reset itself and perform a vacuum test, which is audible as two quick bursts of air. Provided there are no error conditions, such as a vacuum blockage, the applicator is ready to resume normal operation.

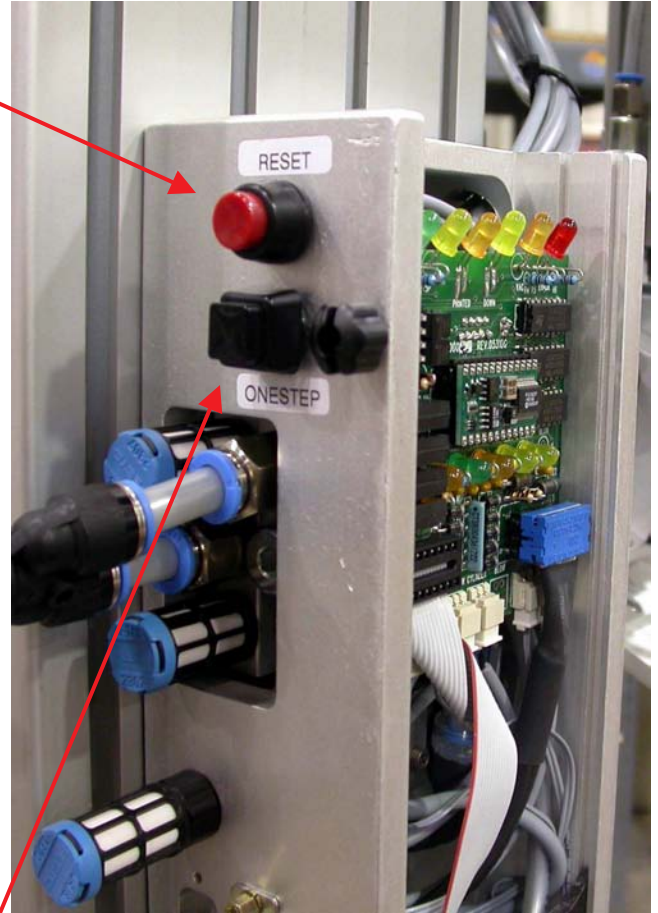

### OneStep button

The *OneStep* button, labeled ONESTEP, is a square, black button located on the top left side of the unit, below the *Reset* button, and also serves dual purposes: (1) To Split the Print and Apply cycle into two steps, and (2) To display the applicator's firmware version.

Pressing the *OneStep* button a single time while a print job is being processed by the printer will cause the label to be printed and fed to the tamp pad. The label will stay here until the *OneStep* button is pressed a second time, when it will be applied to the product.

To display the firmware version of the applicator, verify that no print job is pending in the printer, and hold down the *OneStep* button for three seconds. The firmware version is displayed using the "Down", "Vac.", and "Error" LEDs sequentially. The "Down" LED displays the first digit, the "Vac." LED displays the second digit, and the "Error" LED displays the third digit of the firmware digit.

For Example:

*DOWN LED flashes once = 1*  
*VAC LED flashes three times = 3*  
*ERROR LED flashes five times = 5*  
 Firmware version = 1.35

## Air Supply Valve

The *Air Supply Valve* is a red valve, located on the Air Regulator, which is normally mounted on the H-base stand, but can be placed anywhere near the applicator. It is used to open or close the main air supply to the applicator. When maintenance or adjustments are necessary to the applicator, the air supply should be shut off to prevent damage to the applicator and to prevent injury to the operator.

To turn off the supply air, turn the air supply valve counter-clockwise

To turn the supply air back on, turn the air supply valve clockwise.

**CAUTION:** *When air is restored to the applicator, stay clear of all moving parts or serious injury can occur.*

## Printing and Applying Labels

Once the applicator is fully assembled and the tamp pad has been fitted, it is ready for operation.

1. Verify the air supply is turned on and set to between 5 and 6 bar.
2. Turn on the printer. Some printers, such as the Tharo H-Series printer, will automatically power up the applicator, however different printers may require a separate power supply for the applicator. Once the printer and the applicator are turned on, they will both automatically perform a function test. When the printer's display says: "Ready to print", and the tamp pad is in the up position, the system is ready for operation.
3. At this point, a print job must be sent to the printer. This can come from a computer connected to the printer, or from flash memory on the printer. Please refer to the printer or software manual for further information on sending a job to the printer.
4. Once the job is sent to the printer, a *start* signal is sent to the applicator, either from the *OneStep* button, or from a device connected to the I/O port, such as a foot switch, optical sensor, or PLC). This will cause the applicator to pick up the label, and immediately apply the label to the product.
5. When the pad comes in contact with the product, and a predetermined tamp pressure has been reached, the tamp pad will stop traveling toward the product, and it will return to the up position. When the pad has reached the up position, one labeling cycle has been completed. The applicator is now ready for the next *Start* signal to begin the next cycle.

During each cycle, several safety and operation checks are performed to ensure that the applicator is functioning correctly and that the label has been applied to the product. If any of these inspections fail, an error message will be displayed. Please refer to the Troubleshooting section for a more detailed explanation of these error conditions.

## LED Functions

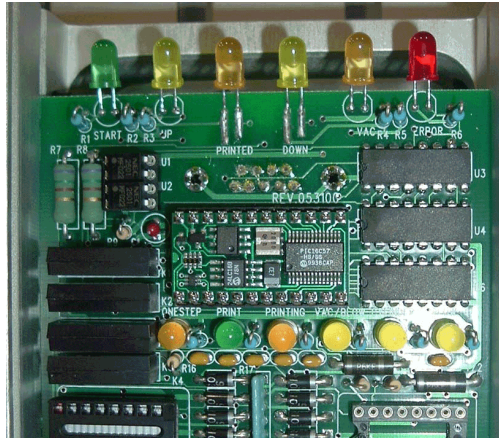

### START –

The green *START* LED is the first LED on the top row. It is used to indicate the *Start* signal, and will stay lit as long as the *Start* signal is high.

### UP –

The yellow *UP* LED is the second LED on the top row, and serves dual purposes. When the tamp pad is in the *up* position, the LED will remain lit, until the pad leaves the *up* position.

The LED is also used to indicate an error condition. When the tamp pad is in the *up* position, and a label begins feeding to the pad, the pad must remain in the *up* position until the label has stopped feeding, or an *up* error will occur. This error can happen if the air supply to the applicator is interrupted. When this *up* error has occurred, the *Error* LED will be lit, the *Up* LED will flash and the *Printed* LED may be lit. The error condition will remain until cleared by the *reset* button, or by sending a *Stop* signal to the applicator's I/O port.

If the applicator has applied a label and has not returned to the *up* position within 3 seconds, an **Up error** will occur. This can happen if the air supply is interrupted, or if the cylinder becomes jammed. When this **Up error** has occurred, the *Error* LED will be lit, and the *Up* LED will flash. The error condition will remain until cleared by the reset button, or by sending a *Stop* signal to the applicator's I/O port.

### DOWN

The yellow *DOWN* LED is the fourth LED on the top row, and serves dual purposes. When the tamp pad reaches the *down* position, the Led is lit, and remains lit until the pad leaves the down position.

If the applicator begins applying a label but does not reach the down position within 3 seconds, a **down error** will occur. This can be caused by interruption in the air supply, or a jammed cylinder.

When the **down error** has occurred, the *error* LED will be lit, the *down* LED will flash, and the *printed* LED may be lit. If the pad is returned to the *up* position, the *up* LED may also be lit. The error condition will remain until cleared by pressing the *Reset* button, or by sending a *stop* signal on the applicator's I/O port.

## VACUUM

The orange *VACUUM* LED is the fifth LED on the top row, and serves multiple purposes. When the applicator feeds a label to the tamp pad, the label blocks the vacuum, and triggers the LED.

The *VACUUM* LED can also be used to display error conditions. When a reset is performed, the vacuum is tested to be sure that there is no blockage of the pad or the vacuum lines. If there is blockage, the “**Vacuum Blocked**” error will occur.

When the “**Vacuum Blocked**” error has occurred, the *error* LED will be lit, the *vacuum* LED will flash rapidly, and if the pad is in the *up* position, the *up* LED will be lit. This error will remain until the blockage is removed, the error is cleared by pressing the reset button, or a *STOP* signal on the applicator I/O port is sent. Refer to the troubleshooting section for more information on clearing a vacuum blockage.

When the “**Label Not On Pad**” error has occurred, the *error* LED will be lit, the *vacuum* LED will flash, and if the pad is in the *up* position, the *up* LED will be lit.

## ERROR

The red *ERROR* LED is the sixth LED on the top row, and indicates an error condition.

When the applicator is in any error condition, this LED will be lit and will remain lit until the error is corrected and the applicator is reset by pressing the *Reset* button, or by sending a *STOP* signal on the applicator I/O port. The exact error is indicated by the flashing LED that corresponds to the error. If the *error* LED is lit but no other LED is flashing, the flashing LED may be stuck on by an overriding sensor. The *up* LED may be on because the pad is in the *up* position, but if the supply air is turned off and the pad is moved from the *up* position, you will see that the *up* LED is actually flashing.

When the printer is in any error condition, this LED will flash, and will remain flashing until the error is corrected at the printer. This error condition can be read from the printer's front panel. The applicator will automatically reset when the error is corrected on the printer.

## ONESTEP

The orange *ONESTEP* LED is the first LED on the bottom row, and indicates the applicator is in *OneStep* mode. (The *OneStep* button has been pressed.)

## VAC/BLOW

The yellow *VAC/BLOW* LED is the fourth LED on the bottom row, and corresponds to the *Vac/Blow* valve.

When the printer begins printing a label, the *vac/blow valve* is turned on and remains on until the *down* signal is received, an error occurs, the label is removed from the pad in *OneStep* mode, the *reset* button is pressed, or until a *STOP* signal on the applicator I/O port is sent.

## CYLINDER

The yellow *CYLINDER* LED is the fifth LED on the bottom row, and is used to indicate the *Apply* process.

After the label is printed and on the pad, the cylinder is turned on to apply the label (in *OneStep* mode, the applicator waits for the second press of the *OneStep* button before proceeding). The cylinder valve is turned on and remains on until the *down* signal is received, until an error occurs, until the *reset* button is pressed, or until a *STOP* signal on the applicator I/O port is sent.

## OPTIONS AND ACCESSORIES

### Warning Beacon

The warning beacon functions as a visual display for printer & applicator errors.



The warning beacon indicates an applicator or printer error. It will go on and remain on until the error is cleared.

#### Connections:

The warning beacon is connected to the I/O port of the applicator with the supplied Y-cable. Be sure that the male connector of the Y-cable is connected to the I/O port of the applicator. One of the female connectors should be connected to the warning beacon. The other female connector can be connected to the optical sensor, timer, foot switch, or PLC.

**WARNING!** Be sure to remember that the Y-cable can allow the same pin of the I/O port to be used in two places at the same time. Never use the Y-cable in a manner that will allow devices to conflict with each other, such as an optical sensor on one end, and a timer on the other. This will blow the power supply in the printer, and can damage the devices as well as the applicator. Only use the Y-cable as described above to prevent problems.

When wiring a PLC, take note of the warning beacon connections in figure 1.

Figure 1

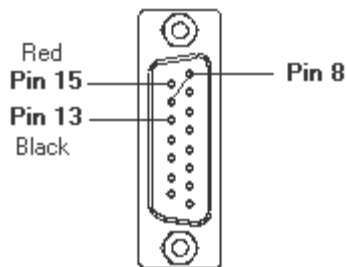

Pin 15 is 24v that is supplied to the light.  
 Pin 14 is the error reverse line, which is connected to pin 8 (ground).  
 Pin 13 is the applicator error which is connected to the negative of the light.

## Product Sensor

The product sensor functions as an automatic trigger device, which sends a start signal to the applicator. The product sensor senses its invisible beam when reflected from the supplied reflector. The yellow indicator LED on the back of the sensor will light when the beam is sensed. When the beam is broken, and the yellow LED is off, the start signal is sent to the device that the sensor is connected to (applicator, timer, or PLC). The reflector can be mounted up to 9 feet away from the sensor. The sensor is not affected by ambient light, or reflective surfaces that are not polarized, (the reflector is polarized). The green LED indicates that the sensor is powered on.



### Connections:

The product sensor can be plugged directly into the I/O port of the applicator, or it may be attached to the female port on the optional product sensor timer, or you may attach it to a PLC for automated applications.

**Note: The product sensor, cable, and connector are shielded to reduce the possibility of static or noise interference. For this reason, replacement sensor, cable, or connector should be of the shielded type.**

### Application Notes:

The following is a list of factors to consider when placing the applicator and optical sensor on a conveyor:

The second product back should not trip the optical sensor until the pad has returned to the *up* position. If this occurs, the label placement will be delayed and cause the label to be positioned too far back or off the back of the product. Long products will not cause a problem. The applicator will not begin the print and apply cycle until the sensor has been reset (turned off by the absence of a product), and then triggered again by another product.

**If the label is too far back on the product**, move the sensor away from the applicator. This will cause the product to trip the sensor sooner, which allows the applicator more time to put the label on the product. The label will then be applied sooner, and therefore closer to the front of the product.

**If the label is too far forward on the product**, move the sensor toward the applicator. This will cause the product to trip the sensor later, which allows the applicator less time to put the label on the product. The label will then be applied later, and therefore further towards the back of the product.

The optional product sensor timer can also be used to adjust the placement of the label. This is accomplished by delaying the start signal using a preset delay in the timer. This can be used for fine-tuning the label placement. It may be useful in applications where the sensor mounting position is limited and does not allow the sensor to be moved in order to adjust label placement. The main use of the timer is to allow accurate placement of a label in the middle of a product when jobs that use different length products are done on the same line.

The conveyor speed must remain constant for the label placement to be consistent. If the conveyor speed fluctuates, the label placement will be erratic.



## Product Sensor Timer

The product sensor timer functions as a 'start delay' or a 'start pulse generator'.

The purpose of the 'start delay' function is to delay the start pulse that is sent from the product sensor. The user sets the delay in the timer, the higher the number the longer the delay. The typical use for this function is to allow for label placement in the middle of the a box when different length boxes in separate jobs on the same conveyor, or to allow a sensor to be mounted to a conveyor in a fixed location, and use the delay value to 'fine tune' the placement of the label. This may be necessary in cases where there is a limited amount of space for the sensor to be mounted, which does not allow adequate adjustment of the sensor to correctly position the label on the product.



The purpose of the 'start pulse generator' function is to produce a start pulse at a timed interval. The user sets the interval in the timer, the higher the number the longer the interval between start pulses. The typical use for this function is to allow a scale to be used in an automated application. After the product is on the scale, and the weight data is sent to the label, the label is ready to print and be applied. The continuous stream of start pulses assures that the label is printed and applied when it is ready.

### Connections:

The timer is connected to the I/O port of the applicator with the supplied 6' timer cable. Be sure that the male connector on the right side of the timer is connected to the I/O port. This will allow the start signal to be sent to the applicator. The female port on the left of the timer will pass through all connections to the I/O port except the start signal. Note: If you wish to trigger the applicator without delay, set the timer to 'delay' mode, and set the value to '0000'.

### Settings:

To set the timer,

- Set the **“Run/Set”** switch to the **“Set”** position
- Set the **“Delay/Strobe”** switch accordingly
- Use the **“Up/Down”** buttons to set the time
- Set the **“Run/Set”** switch to **“Run”**

The timer will not send a start signal when the **“Run/Set”** switch is in the **“Set”** position.

## Foot Switch

The foot switch functions as a manual trigger device, which sends a start signal to the applicator when it is pressed.

### Connections:

The foot switch is plugged directly into the I/O port of the applicator.



## Locking Casters Set

The locking casters are an upgrade to the leveling feet that came with your PA1200 stand. When fitted with the set of locking casters, the PA1200 can be easily rolled to a different location. The casters can then be locked with a press of the lock lever, and the stand is now solidly positioned for continued use.

### Installation:

Unbolt the leveling feet from the stand, and remove the nut from each leveling foot. Screw one nut on each caster then screw the casters on the stand. After leveling the stand, by screwing each caster in or out as necessary, tighten the nut up against the bottom of the stand to secure each caster in place.

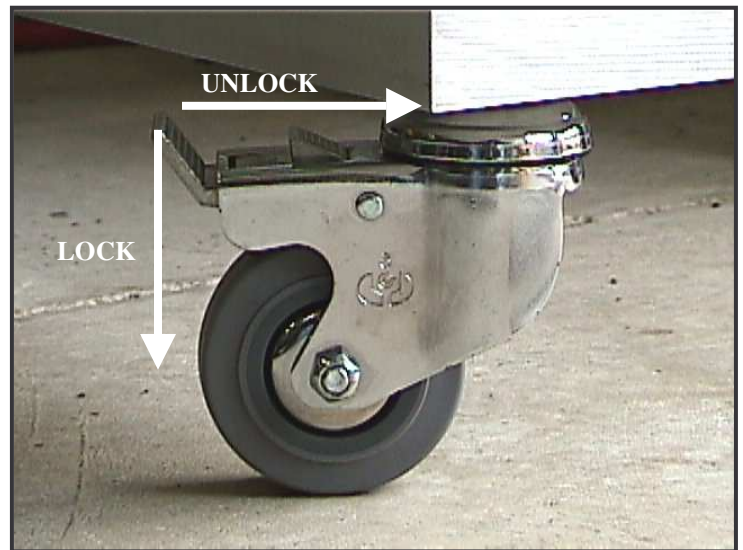

### Settings:

To unlock the casters, press the lever back on the top of each caster. The wheel will now roll and the caster can swivel.

To lock the casters, push the lever down. Both the wheel and the swivel will be locked.

## Low Pressure Shutoff

### Description:

The low pressure shutoff is an optional safety device that monitors the air supply and actuates when the pressure drops below a safe operating pressure. Actuation halts the PA1200 and retains air in the system in order to hold the pad in the up position and out of the way of potential damage from oncoming products.

### Connections:

The low pressure shutoff is attached to the air supply side of the filter regulator. The 15 pin connector is attached to the supplied Y-cable which is attached to the 15 pin I/O port of the PA1200.

### Function:

The low pressure shutoff monitors the supply air. When the pressure drops either slowly, or suddenly, the red low pressure LED on the shutoff will come on, and a stop signal is sent to the PA1200. This will cause the pad to return and stay in the up position, and all applicator functions will be suspended until the pressure is brought back up to normal operating levels.

**Note: Slow leaks in the system, or manual operation of the valves will dissipate the trapped air in the system and prevent the pad from staying in the up position.**



## External Unwind/Rewind

The External Unwind/Rewind is an accessory for the Tharo series of applicators. With the ability to accommodate up to a 16-inch roll of labels, the External Unwind/Rewind will help to increase productivity by decreasing the number of label roll changes throughout the workday.

### Installation:

If you have ordered an External Unwind/Rewind with your applicator system, then you have received an extended base plate. The Unwind/Rewind attaches to the back of the base plate with four (4) bolts.

Once secured to the base plate remove the outer disk on the label Unwind (smoke color disk). Load the labels onto the supply hub and secure the outer disk back into place. Thread the labels under the label hold down bar and into the printer. Load the labels through the printer as directed in the printer manual. Make sure that all of the guides are up against the label liner to prevent the labels from moving side to side within the printer.



Thread the liner through the tension bars as shown. Attach the label liner to the rewriter take up. Do this by removing the U shaped clasp on the take up hub and wrap the label liner around it. Then replace the clasp to secure the liner in place. Replace and secure the outer discs.

Make sure that the 'On/Off' switch on the External Unwind/Rewind is in the 'Off' position

Keep your hands, loose clothing, etc. away from any moving parts when powering up the machine.

Plug one end of the power supply into the back of the Unwind/Rewind. Plug the other end of the power supply into a grounded outlet. **DO NOT** power up the Unwind/Rewind until the labels are fully threaded and secured to the take-up hub.

### Maintenance:

The External Unwind/Rewind is virtually maintenance free. The only serviceable parts are the label hold down bar, and the tension bars. Make sure that they are clean at all times, free of adhesive. This will ensure that the labels will move freely through the machine.

## H-Base Stand

The Hand-Cranked Height Adjustable H-Base Stand is used to hold the Printer/Applicator over a conveyor or work cell. The Hand-Crank allows for extremely precise height adjustments, while offering stability and ease of use. The stand can be equipped with locking casters for easy relocation.

See **H-Base Assembly** for setup instructions.



## PLC PORT

Sensors, lights, timers, a foot switch and PLCs can be connected to the applicator through the 15 pin Sub-D I/O (PLC) port, which is located on the side of the applicator. This port is used to control and monitor the applicator.

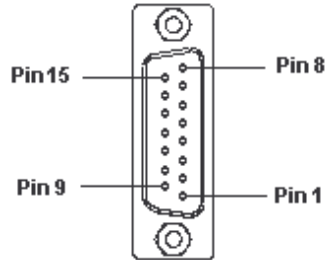

### Pin Assignment

Pin	Signal	Direction	Function
1	START+	input	START signal positive
2	STOP+	input	STOP signal positive
3	P8		not defined
4	P4		not defined
5	P10		not defined
6	+5V		+5V <300mA
7	UP_I/O	output	pad in up position
8	GND		ground
9	START-	(input)	START signal negative
10	STOP-	(input)	STOP signal negative
11	P9		not defined
12	DOWN_I/O	output	pad in down position
13	PRINTER		printer/applicator error
14	RELAY_COMMON		common for all outputs
15	+24V		+24V <1A

## Input Description

The inputs are optocouplers with a 750-ohm current limiting resistor in series with the input.

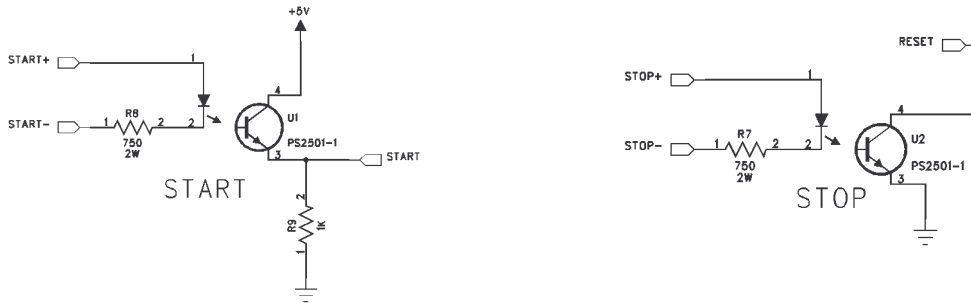

## Input Requirements:

**START**      35mA at 24V  
                   7mA at 5V

**STOP**         35mA at 24V  
                   7mA at 5V

## Output Description

The outputs are relays with one side of each relay (common) tied to pin 14.

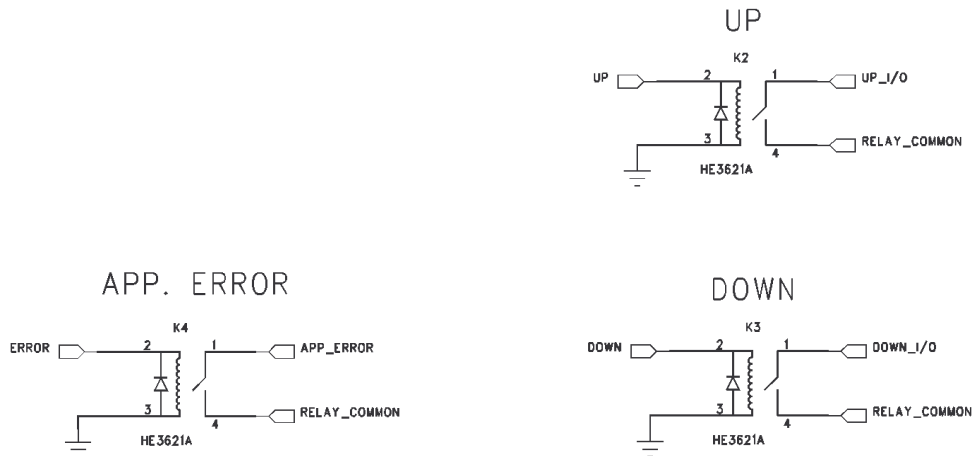

## Output Capabilities

UP\_I/O  
 DOWN\_I/O  
 PTR/APP\_ERROR

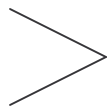

250mA at 40VDC  
 100mA at 70VAC rms

NOT TO EXCEED 10W  
 DISSIPATION OR 100V  
 (AC or DC) PEAK

## Signal Explanation

### START+ and START- (pin 1 and 9)

Pin 1 and 9 are inputs for the control of the label print and apply process. When a *START* signal is sent to the applicator, and a job is present in the printer, a label will be printed, fed to the pad and applied, all in one continuous process.

If no job is present in the printer, the *START* signal will be ignored.

### These pins can be wired in the following configurations:

#### Internal 5V Power using a Microswitch

*START+(pin 1) connected to +5V (pin 6), and START- (pin 9) connected to GND (pin 8)*

This will send a *START* signal to the printer, and the *START* LED should light. Disconnecting either the +5V or the GND and then reconnecting will send another signal. For this reason, a non-powered microswitch can be placed on either the +5V side (remove wire and connect switch to pin 1 and 6) or on the GND side (remove wire and connect switch to pin 8 and 9).

#### Internal 24V Power using a Microswitch

*START+(pin 1) connected to +24V (pin 15), and START- (pin 9) connected to GND (pin 8)*

This will send a *START* signal to the printer, and the *START* LED should light. Disconnecting either the +24V or the GND and then reconnecting will send another signal. For this reason, a non-powered microswitch can be placed on either the +24V side (remove wire and connect switch to pin 1 and 15) or on the GND side (remove wire and connect switch to pin 8 and 9).

#### External High Trigger (5V to 24V)

*START+ (pin1) connected to an external high pulse ( 5 to 24V ), and START- (pin9) connected to GND (pin8, or external GND)*

When an external device, such as an optical sensor or a PLC, sends a high to the *START+* (pin1) and the *START-* is grounded, a valid *START* signal is sent to the applicator and the *START* LED should light.

#### External Low Trigger

*START+ (pin1) connected to either 5V (pin6 or external 5V) or 24V (pin15 or external 24V), and START- (pin9) connected to an external low pulse ( GND, 0V ).*

When an external device, such as an optical sensor or a PLC, sends a low to the *START-* (pin9) and the *START+* is connected to 5 to 24V, a valid *START* signal is sent to the applicator and the *START* LED should light.



**STOP+ and STOP- (pin 2 and 10)**

Pins 2 and 10 are inputs for the *STOP*, and *ERROR RESET* functions. The applicator can be immediately stopped at any time by providing a *STOP* signal. The current function will cease and the applicator will return the pad to the *up* position and reset itself.

When an applicator error occurs, it can be cleared by sending the *STOP* signal. It is important to be sure that the cause of the error is corrected, or the error may reoccur.

**These pins can be wired in the following configurations:**

## Internal 5V Power using a Microswitch

*STOP+(pin 2) connected to +5V (pin 6), and STOP- (pin 10) connected to GND (pin 8)*

This will send a *STOP* signal to the printer and the applicator will stop operating and reset itself. Disconnecting either the +5V or the GND and then reconnecting will send another signal. For this reason, a non-powered microswitch can be placed on either the +5V side (remove wire and connect to switch to pin 1 and 6) or on the GND side (remove wire and connect switch to pin 8 and 9).

## Internal 24V Power using a Microswitch

*STOP+(pin 2) connected to +24V (pin 15), and STOP- (pin 10) connected to GND (pin 8)*

This will send a *STOP* signal to the printer and the applicator will stop operating and reset itself. Disconnecting either the +24V or the GND and then reconnecting will send another signal. For this reason, a non-powered microswitch can be placed on either the +24V side (remove wire and connect switch to pin 1 and 15) or on the GND side (remove wire and connect switch to pin 8 and 9).

## External High Trigger (5V to 24V)

*STOP+ (pin2) connected to an external high pulse (5 to 24V), and STOP- (pin10) connected to GND (pin8, or external GND)*

When an external device, such as an optical sensor or a PLC, sends a high to the *STOP+* (pin2) and the *STOP-* is grounded, a valid *STOP* signal is sent to the applicator and the applicator will stop operating and reset itself.

## External Low Trigger

*STOP+ (pin2) connected to either 5V (pin6 or external 5V) or 24V (pin15 or external 24V), and STOP- (pin10) connected to an external low pulse (GND, 0V)*

When an external device, such as an optical sensor or a PLC, sends a low to the *STOP-* (pin10), and the *STOP+* is connected to 5 to 24V, a valid *STOP* signal is sent to the applicator and the applicator will stop operating and reset itself.

## UP\_I/O and RELAY\_COMMON (pin 7 and pin 14)

Pins 7 and 14 are outputs for the *Up* Position Indicator and the **Up Error** indicator. When the pad is in the *up* position, the UP\_I/O relay will be energized. The UP\_I/O relay will be de-energized as soon as the pad leaves the *up* position.

1. If the pad is in the *up* position and a label begins feeding to the pad, the pad must remain in the *up* position until the label has stopped feeding or an *up* error will occur.

When this *up* error has occurred, the APP\_ERROR relay will be energized and the UP\_I/O relay will strobe on and off. If the pad is returned to the *up* position, the UP\_I/O relay will stop strobing, but the error will remain until cleared by pressing the *Reset* button or by sending a *STOP* signal on the applicator I/O port.

2. If the applicator has applied a label and has not returned to the *up* position within 5 seconds, an **up error** will occur.

When this *up* error has occurred, the APP\_ERROR relay will be energized and the UP\_I/O relay will strobe on and off. If the pad is returned to the *up* position, the UP\_I/O relay will stop strobing, but the error will remain until cleared by pressing the *Reset* button or by sending a *STOP* signal on the applicator I/O port.

### These pins can be wired in the following configurations:

#### Source Output

*Connect the RELAY\_COMMON (pin14) to -40 to 40 VDC (this can be supplied from the port +5V on pin 6 or +24V on pin 15, or this can come from an external source), and when the UP\_I/O relay is energized, this voltage will be supplied at UP\_I/O (pin7)*

#### Sink Output

*Connect the RELAY\_COMMON (pin14) to Ground (pin 8 of the I/O port, or an external ground, and when the UP\_I/O relay is energized, this path to ground will be supplied at UP\_I/O (pin7)*

#### AC Output

*Connect the RELAY\_COMMON (pin14) to 1 to 70 VAC (from an external source), and when the UP\_I/O relay is energized, this voltage will be supplied at UP\_I/O (pin7)*

## **DOWN\_I/O and RELAY\_COMMON (pin 12 and pin 14)**

Pins 12 and 14 are outputs for the *Down* Position and the **Down Error** Condition. When the pad has reached the *down* position, the DOWN\_I/O relay Indicator will be energized. The DOWN\_I/O relay will be de-energized as soon as the pad leaves the *down* position.

If the applicator begins applying a label but does not reach the *down* Indicator position within 3 seconds, a *down* error will occur.

When the *down* error has occurred, the APP\_ERROR relay will be energized and the UP\_I/O relay will strobe on and off. The error will remain until cleared by pressing the *Reset* button or by sending a *STOP* signal on the applicator I/O port.

### **These pins can be wired in the following configurations:**

#### Source Output

*Connect the RELAY\_COMMON (pin14) to -40 to 40 VDC (this can be supplied from the port +5V on pin 6 or +24V on pin 15, or this can come from an external source), and when the DOWN\_I/O relay is energized, this voltage will be supplied at DOWN\_I/O (pin12)*

#### Sink Output

*Connect the RELAY\_COMMON (pin14) to Ground (pin 8 of the I/O port, or an external ground, and when the DOWN\_I/O relay is energized, this path to ground will be supplied at DOWN\_I/O (pin12)*

#### AC Output

*Connect the RELAY\_COMMON (pin14) to 1 to 70 VAC (from an external source), and when the DOWN\_I/O relay is energized, this voltage will be supplied at DOWN\_I/O (pin12)*

---

## **PTR/APP\_ERROR and RELAY\_COMMON (pin 13 and pin 14)**

Pin 13 and 14 are outputs for the **Printer/Applicator Error** condition. When the applicator is in any error condition, the APP\_ERROR will be energized, and will remain energized until the error is corrected and the applicator is reset by pressing the Reset button or by sending a *STOP* signal on the applicator I/O port. The exact error is indicated by the corresponding flashing LED. If the error LED is lit but no other LED is flashing, the flashing LED may be stuck on by an overriding sensor. For example, the *Error* LED could be lit, but no LED is flashing. The *Up* LED may be on because the pad is in the up position, but if the supply air is turned off and the pad is moved from the *up* position, you will see that the *Up* LED is actually flashing.

### **These pins can be wired in the following configurations:**

#### Source Output

*Connect the RELAY\_COMMON (pin14) to -40 to 40 VDC (this can be supplied from the port +5V on pin 6 or +24V on pin 15, or this can come from an external source), and when the APP\_ERROR relay is energized, this voltage will be supplied at APP\_ERROR (pin13)*

#### Sink Output

*Connect the RELAY\_COMMON (pin14) to Ground (pin 8 of the I/O port, or an external ground, and when the APP\_ERROR relay is energized, this path to ground will be supplied at APP\_ERROR (pin13)*

#### AC Output

*Connect the RELAY\_COMMON (pin14) to 1 to 70 VAC (from an external source), and when the APP\_ERROR relay is energized, this voltage will be supplied at APP\_ERROR (pin13)*

## FIRMWARE

### Checking the applicator's firmware version:

With the air turned off, and the tamp in the down position, hold down the OneStep button. The last three LEDs (down, vacuum and error) will begin flashing in order. Continue to hold the *OneStep* button in order to keep the LEDs flashing. The flashes will correspond to the number for each digit.

*For example:*

*DOWN LED flashes once = 1*  
*VAC LED flashes three times = 3*  
*ERROR LED flashes five times = 5*  
*Firmware version = 1.35*

*(In order to prevent confusion, zeros are not used in the firmware version.)*

### Downloading new firmware:

The applicator firmware can be upgraded as needed in the field without hardware changes. The firmware is stored in flash memory and new firmware can be downloaded to the applicator mainboard through the 9-pin serial connector on top of the mainboard using a standard RS-232 serial cable connected to your computer.

### Upgrading firmware:

If there is power to the printer at this point, turn it off before proceeding. The cover fastener is located on the upper front of the left side of the applicator.

Loosen this - do not remove it. Slide the front cover up and completely off of the applicator.

Locate the 9-pin serial connector on the back, top of the applicator mainboard. Connect one end of a 9-pin RS-232 serial cable to this connector.

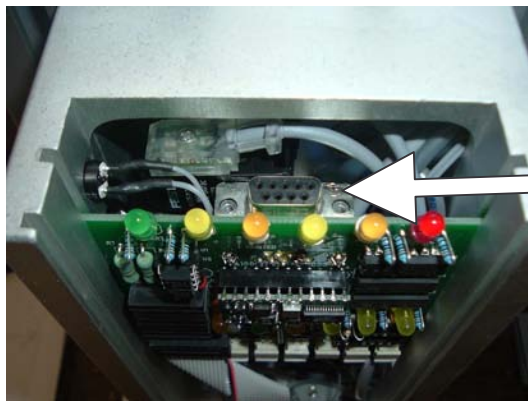

Serial Connector

Connect the other end to your PC serial port and turn on the printer.

Start the firmware upgrade utility and follow the onscreen instructions.

## TROUBLESHOOTING

### Changing The Tamp Pad

1. Turn the air off at the regulator.

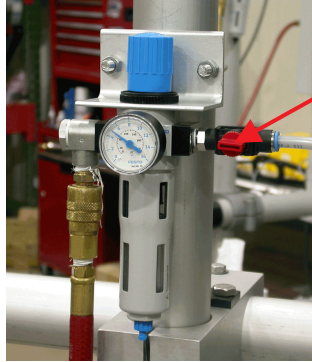

2. Lower the applicator arm.

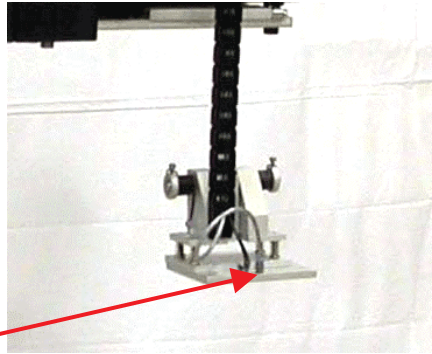

3. Remove the vacuum hose from the quick-release fitting on the tamp pad.
4. Remove the 4 screws from the tamp pad with a 2.5mm Allen Wrench to free the pad from the lower spring plate.
5. Secure the new tamp pad to the lower spring plate using the 4 screws and Allen Wrench.
6. Attach the vacuum hose to the quick-release fitting on the tamp pad.
7. Turn the air back on at the regulator.

## Adjusting The Vacuum Sensor

1. Loosen the cover fastener and remove the applicator front cover

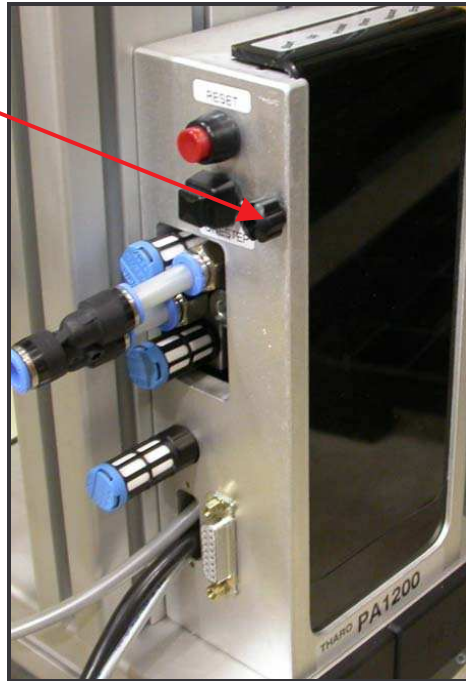

2. Using a small, precision, flat-head screwdriver, tighten the screw inside the hole clockwise while repeatedly pressing the Red, "Reset" button.

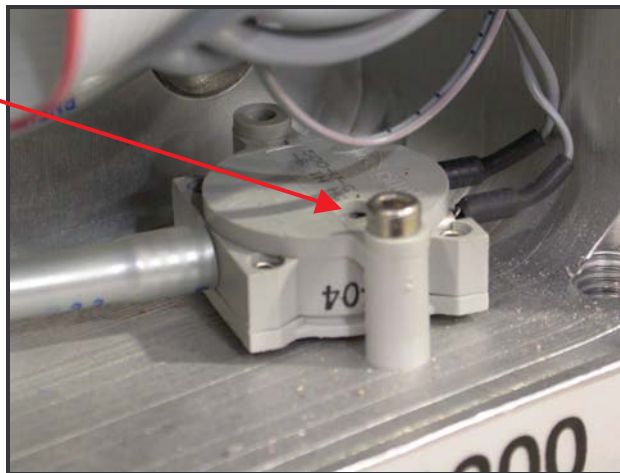

3. Continue turning the screw clockwise until The Error Led is lit.
4. Once the Error Led is lit, turn the screw slightly counter-clockwise and press the Red, "Reset" button again to clear the error.

## Label Synchronization

It may be necessary to discard the first label if it was not fully printed or if it did not feed correctly. This can occur if the labels are not positioned in the exact spot under the printhead for printing to start in the correct place. Should this problem arise, check for the following conditions:

1. The erroneous label is the first label of the first job printed on this printer
2. The printhead has been opened for changing the ribbon or labels, or for cleaning purposes
3. The label size has been changed (in software)

In most cases, the labels can be properly positioned before sending a print job to the printer. This is accomplished by pressing the Feed button on the printer twice. If, at any time, one of the above-listed conditions occurs, simply discard the blank labels that feed out.

If the label stock or ribbon is changed during the printing of a job, it may be necessary to discard the first label when printing is resumed.

If power is removed from the printer after the labels have been correctly positioned, power can be later restored and the labels will print normally.



## Problem / Cause / Solutions

**1. Problem:** Up Error (*Error LED is lit and the Up LED is flashing*)

*Occurs when:*

- The pad stays in the *up* position after label feeding.
- The pad does not return to the *up* position within three seconds of reaching the *down* position.
- The applicator mainboard has malfunctioned.

**Cause:**

- There is a permanent/temporary loss or drop of air supply pressure.
- The cylinder is jammed by a moving object that has pulled the pad from the *up* position or by an object that is blocking it from returning to the *up* position.
- The up sensor clamp has been damaged or has worked loose from its original position. The sensor is no longer in the correct position to sense that the pad is in the *up* position

**Solution:**

- A larger compressor or larger supply lines may be required to maintain the necessary air pressure to the applicator. The applicator requires 5 CFM at 6 bar (90psi).
- Install the necessary guards or safety rails to prevent external obstructions, such as fingers, hands or arms, machinery, or surrounding product or packaging, from interfering with the labeling process at the applicator.
- Reposition the up sensor to the correct position on the cylinder shaft. When the pad is the *up* position, the up LED should be on. If you move the pad out of the *up* position, the LED should be off. If the LED is on and then goes off and back on as the pad is moved out of the *up* position, the sensor is positioned too low. Move the sensor up and try again.
- The applicator may need servicing. Replace the faulty sensor or mainboard.

**2. Problem:** Down Error (*Error LED is lit and the Down LED is flashing*)

*Occurs when:*

- The applicator begins applying a label but does not reach the *down* position within 3 seconds.
- The down sensor is malfunctioning, and therefore cannot detect the pad in the *down* position.

- Cause:**
- The cylinder is jammed.
  - The product to be labeled is not present at the time the pad has reached the labeling position.
  - The down sensor has malfunctioned or has been moved.
  - The applicator mainboard has malfunctioned.

- Solution:**
- Install the necessary guards or safety rails to prevent external obstructions, such as fingers, hands or arms, machinery, or surrounding product or packaging, from interfering with the labeling process at the applicator.
  - Check the product flow and product sensors. The product may be obstructed from entering the labeling position, or the product sensor may be triggering falsely when no product is present.
  - The applicator may need to be serviced.
  - Replace the faulty sensor or mainboard.

**3. Problem:** Vacuum Blocked Error (*Error LED is lit and the Vacuum LED is flashing rapidly*)

*Occurs when:*

The vacuum is being tested at power up, or after the *reset* button is pressed under one of the following conditions:

- The holes on the pad are covered.
- The channels in the pad are blocked.
- The vacuum lines running to the pad are blocked.
- The pneumatics are blocked.
- The vacuum sensor has malfunctioned.
- The applicator mainboard has malfunctioned.

- Cause:**
- There is a label stuck on the pad.
  - Dust, dirt or some other foreign substance has caused a blockage in the pad, vacuum lines or pneumatics.
  - Water or oil from the main air supply has accumulated in the pneumatics.

- Solution:**
- Remove the stuck label from the pad.
  - Remove the blockage, or replace the blocked components.
  - Install the necessary filters to remove all water and oil from the supply air.
  - The applicator may need to be serviced. Replace the faulty sensor or mainboard.
  - Adjust the Vacuum Sensor. See “Adjusting The Vacuum Sensor” for more information

**4. Problem:** Label Not On Pad Error (*Error LED is lit and the Vacuum LED is flashing*)

*Occurs When:*

- The label was printed and fed out to the pad, but all of the holes on the pad were not covered.
- The label was printed and fed to the pad, and the holes were covered, but when the pad started moving, the label was pulled off of the pad by the edge of the label still in the printer or by the liner.
- The label did not stay on the pad long enough to reach the product.
- The vacuum sensor has malfunctioned.
- The applicator mainboard has malfunctioned.

- Cause:**
- The label is too small for the pad or the holes are in the wrong place for the size label that is being used.
  - The presentation position value has been set too high, therefore causing the next label to hang over the peel edge and intercept the printed label on the way down to the product.
  - The presentation position value has been set too low and the printed label's trailing edge did not separate from the liner. The label is pulled off of the pad on the way to the product.
  - Something has intercepted the label from the pad on the way to the product.

- Solution:**
- Be sure to use the correct pad for the label size that you are using.
  - Adjust the presentation position. There may be slight manufacturing tolerances that vary from printer to printer that will make it necessary to change this setting. The presentation position should be set so that the second label's leading edge is 1mm behind the peel edge when the first label out has stopped moving and is on the pad. This can be checked with the *OneStep* button.
  - Check for and eliminate any obstructions that may prevent the label from not reaching the product.
  - The applicator may need to be serviced. Replace the faulty sensor or mainboard.

**5. Problem:** Printer Error (*Error LED is lit by itself*)

*Occurs when:*

An error occurs within the printer

**Cause:** See the printer manual for information on printer errors

**Solution:** See the printer manual for troubleshooting information

**6. Problem:** Cutter Jam error message on printer LCD. No label is printed.

**Cause:** The “Option Setup” setting in the printer is set to “Peel Off”, “Tear Off”, or “Batch” mode.

**Solution:** Change the “Option Setup” setting in the printer to “Applicator Mode”. Refer to the printer maintenance manual for instructions on where to find this setting, and how to change it.

**7. Problem:** The labels are not reaching the pad and/or fields are overlapping

**Cause:**

- Drive roller is dirty. Paper, dust, adhesive, and/or a label are on the drive roller.
- Print speed is too high

**Solution:**

- Clean the drive roller
- Decrease the print speed to slowest possible speed for the job.

**8. Problem:** The Tamp Pad is stopping before completing the full down stroke.

**Cause:**

- The label is being fed too far and the second label is hanging over the peel edge
- The label is not being fed out far enough to separate from the liner
- The applicator is damaged; the pad is too close to the peel edge and is making contact with it on the way down.

**Solution:**

- Reduce the presentation position until the second label is out 1mm in back of the peel edge.
- Increase the presentation position until the printed label separates from the liner and the second label out is 1mm in back of the peel edge.
- Service the applicator

- 9. Problem:** There is a thin white line across the format.
- Cause:**
- The backfeed setting in the printer's front panel is set to smart
  - The label stock is being pulled from the printer
  - The label stock is not traveling at a constant rate
- Solution:**
- Turn off Smart backfeed in the printer's front panel.
  - If possible, move the fields in the area of the line so that the line falls in the white space and is not visible.
  - Reduce the rewind tension.
  - Service the printer.
- 10. Problem:** The first label in the job is not placed correctly when using a conveyor
- Cause:** When the first label is printed, the entire label and part of the second label is actually printed. This takes longer than when the second label is printed, since part of it has already been printed. For this reason, the first label will be applied slightly later than the rest of the labels. This means that, on a conveyor, it will be applied later to the product than the rest of the labels in that job.
- Solution:** Turn off the Smart Backfeed option in the printer's front panel.
- 11. Problem:** Labels are not applied to the same place on the product when using a conveyor
- Cause:**
- The speed of the conveyor is not constant
  - The size of the product varies
  - The product is not straight as it approaches the sensor
- Solution:**
- Regulate the speed of the conveyor so that it remains constant
  - Keep in mind that the label will always be applied at the same distance from the leading edge of the product, so if different size products are used, the label will not always be applied to the middle of the product.
  - Guide rails may be necessary to align products on the conveyor as they approach the applicator.

- 12. Problem:** Random errors when the pad makes contact with the product
- Cause:** ESD (Electrostatic Discharge). Static charge can buildup on a product during movement into the labeling position. The charge is then discharged through the printer/applicator to ground when the pad makes contact with the product.
- Solution:** Install a static discharging device such as a static discharge brush. The brush should contact the product before the applicator. This will allow the static to discharge through the brush to ground before it discharges through the printer or applicator, potentially causing the printer or applicator to display random errors.
- 
- 13. Problem:**
- Poor Print Quality
  - Ink smearing
  - Poor ink adhesion to label
  - Poor print quality
  - Premature printhead failure
- Cause:**
- Wax based ribbons are being used on synthetic label stocks
  - Resin-based ribbons used on paper label stock
  - Use of labels not developed for a thermal transfer printer
  - The label stock requires a higher or lower heat setting in the printer
  - The thermal coating is too abrasive
- Solution:** Use proper ribbon and label stock.
- 
- 14. Problem:** The labels are difficult to peel off or are not being removed consistently from the backing.
- Cause:** The gap between the cutting die and the anvil was set incorrectly on the press. The result can either be a die strike that is too deep or too shallow. A deep die strike breaks through the liner surface, thereby exposing the paper interior to the adhesive. The adhesive then grips the liner, which can make dispensing difficult. To test for this, use a black felt-tipped marker to outline the die cutting area. If a solid black line appears along the die cut, the die strikes are too deep. A shallow die strike will not properly cut through the adhesive and could leave adhesive 'legs' that hold on to the label stock.
- Solution:** Use a different type of labels

- 15. Problem:**
- Labels lift up or drop off as the liner is pulled through the machine.
  - Labels are difficult or impossible to peel.
- Cause:**
- During label construction, the adhesive coater can adjust the amount of release agent on the liner that will affect the amount of tension required to release a label from the liner. If the labels are lifting as they travel through the equipment, the release was set too low during label construction.
  - If labels are difficult to peel off, the release was most likely set too high.
- 16. Problem:** Labels near the end of the label roll have a permanent curl that will make it difficult for the vacuum system to hold the label in place on the tamp pad
- Cause:** The label roll ID is too small, (the standard core size is 3").
- Solution:** Any label five inches or longer should use a 5" ID label core.
- 17. Problem:**
- The label liner sticks, as the labels are unwound from the roll, adhesive buildup is visible on equipment rollers
  - The label rolls are difficult to pick up and mount because the center core falls out or telescopes
- Cause:**
- If the labels are wound too tight, adhesive can escape from under the label, which causes the liner to stick.
  - If the labels are wound too loosely, the core can fall out. For this reason, it is crucial that the label supplier has the experience and knowledge required to specify and monitor the correct wind to avoid any potential tension problems.
- 18. Problem:** In applications where the label must fit within a tight space, the label will occasionally be too large or too small on the same roll, which can cause the label printer to periodically lock up and display a label length error message.
- Cause:** The label converter used the incorrect web tension during the die cutting operation.



- 19. Problem:**
- The label is difficult to peel.
  - The liner breaks.

- Cause:**
- The liner is too thick for the label printer or applicator peel plate, and therefore does not provide enough release tension for the label.
  - The liner is too thin to handle the tension and will break as it is pulled through the machine. This condition can be aggravated when there are die strikes on the liner.

**Solution:** Use a different type of labels

- 20. Problem:** As the label is peeled from the backing, the label wrinkles or falls off the tamp pad.

**Cause:** As the label is stripped from the backing, a minimum label stiffness is required to move the label out, under the tamp pad. Labels lacking sufficient stiffness tend to curl and fall off the pad.

- 21. Problem:** Testing

It is strongly recommended that any changes in the supplies undergo thorough testing. This, however, does not mean carrying out a test run with the supplies on a machine for one day, but rather a test should be carried out throughout its *required useful life*. For example, a label intended for use within a manufacturing plant or warehouse will have different testing requirements than a label that must be stored in an unheated warehouse in the winter.

- 22. Problem:** Environmental

Label stocks normally perform better in colder temperatures because the adhesive is less tacky. Always store labels in the same room/environment as the PA1200 for at least 24 hours before use.

When choosing the label stock, we recommend that you contact the label manufacturer to request stock that is guaranteed to dispense on a standard tabletop printer. All testing on the PA1200 has been carried out using Fasson® TransTherm 1C with 2501 Adhesive.

- 23. Problem:** There is not enough air pressure to blow the label onto the product.
- Cause:**
- There is a kink in the air hose.
  - The air pressure is set too low.
- Solution:**
- Check all hoses for kinks and straighten hoses to allow air flow.
  - Set the air regulator to between 5 and 6 bar.
- 24. Problem:** Labels stick to the tamp pad
- Cause:** There is adhesive from the label stock on the tamp pad.
- Solution:** Clean the tamp pad
- 25. Problem:** Labels are not placed correctly on the product when using a conveyor
- Cause:** The sensors are not located in the correct place.
- Solution:** See “Setup Notes” for instructions on how to adjust the sensors to control label placement.
- 26. Problem:** Printer is in an error condition but the applicator continues to run.
- Cause:** Vacuum Sensor is out of adjustment
- Solution:** See “Adjusting The Vacuum Sensor” for instructions.

## Setup / Media Problems

**Pressure changes in the supply air are one of the most common causes of fluctuations in the performance of a label printer/applicator and other pneumatic devices.**

**A sudden drop in the supply air pressure can occur if the air supply lines are inadequate and cannot handle periodic pressure drops. These pressure drops can take place during the initialization and operating cycles of pneumatic equipment. As a result, the label can jam and not be applied to the product. This problem is very difficult to identify due to its random nature. For example, the air pressure may already have returned to normal levels by the time an operator or maintenance person arrives to repair the equipment.**

Attempting to identify and diagnose equipment problems will be ineffective, since the real culprit is ultimately the air supply. This dilemma can be resolved with a pneumatic monitoring device, such as Festo part number 9349APL-2N-PEV, which continuously monitors the air supply line for pressure drops. When the air pressure drops to a preset level, a beacon light on the label printer/applicator automatically signals to the operator that the air pressure has dropped below the required pressure level.

**Loss of air pressure, when using the PA1200 for top apply, will cause the pad to drop. If the conveyor is not stopped oncoming products can run into the extended pad, and cause damage.**

In applications where there is a risk of losing air pressure to the applicator, and oncoming products can be damaged or can damage the applicator, steps should be taken to automatically stop the conveyor. Use of the above mentioned pneumatic monitoring device, which continuously monitors the air supply line for pressure drops, can be wired to a kill switch that stops the conveyor, or to a PLC which controls the conveyor.

### Unique Label Mode

The unique label mode is the most demanding application because each label is different from the previous one. Each label to be printed must be sent from a computer. The label is then printed and applied to the product, and the PA1200 is ready for the next label. This requires continuous communication between the computer and the printer. Complications will arise if the label information is not sent in time, if a communication error occurs or if the printer is out of labels or ribbons. All of these factors add to the complexity of the system.

The standard labels for use with most label printers consist of the following materials:

- Liner or carrier sheet
- Liner release coating
- Adhesive
- Label material
- Label topcoat

The ribbons consist of the following materials:

- Silicone
- Carrier sheet
- Wax or resin ink

## LED Overview

First Row LEDs						Second Row LEDs					Indicated Condition
Start	Up	Printed	Down	Vacuum	Error	OneStep	Print	Printing	Vac/Blow	Cylinder	
○	◐	○	○	○	●	○	○	○	○	○	Up Error*
○	○	○	◐	○	●	○	○	○	○	○	Down Error*
○	○	○	○	◑	●	○	○	○	○	○	Vacuum Blocked**
○	○	○	○	◐	●	○	○	○	○	○	No Label on Pad*
○	○	○	○	○	●	○	○	○	○	○	Printer Error

●	○	○	○	○	○	○	○	○	○	○	Start Signal
○	●	○	○	○	○	○	○	○	○	○	Tamp Pad is in Up Position
○	○	○	●	○	○	○	○	○	○	○	Tamp Pad is in the Down Position
○	○	○	○	●	○	○	○	○	○	○	Vacuum is in use
○	○	○	○	○	●	○	○	○	○	○	Flashing LED is stuck on overriding sensor

○	○	○	○	○	○	●	○	○	○	○	Applicator is in One-Step mode
○	○	○	○	○	○	○	○	●	○	○	Corresponds to the Vac/Blow Valve
○	○	○	○	○	○	○	○	○	○	●	Indicates the Apply Process

\*Printed LED may also be lit

\*\*Printed & Up LEDs may also be lit

### Key:

●	LED On	◐	LED Flashing
○	LED Off	◑	LED Flashing Rapidly

---

## WARRANTY INFORMATION

### 1. Applicator Warranty

THARO Applicators are warranted against defects in material or workmanship for a period of 12 months (365 days) or 1,000,000 cycles of use from the date of original shipment by THARO SYSTEMS, INC. This warranty does not cover normal wear and tear and shall be null and void if the equipment is modified, improperly installed or used, damaged by accident or neglect, or in the event any parts are improperly installed or replaced by the user.

---

THARO SYSTEMS' SOLE OBLIGATION UNDER THIS WARRANTY SHALL BE TO FURNISH PARTS AND LABOR FOR THE REPAIR OR REPLACEMENT OF PRODUCTS FOUND TO BE DEFECTIVE IN MATERIAL OR WORKMANSHIP DURING THE WARRANTY PERIOD.

---

As a condition of this warranty, the user must: (a) obtain a THARO Return Authorization for the applicator or subassembly (s); (b) ship the applicator or subassembly (s), transportation prepaid to the authorized service location; and (c) include with the Product or subassembly (s) a written description of the claimed defect. Unless THARO SYSTEMS authorizes return of the entire Product, the user shall return only the subassembly (s). Products returned shall be packaged in the original packing and shipping container or comparable container. In the event equipment is not so packaged or if shipping damage is evident, it will not be accepted for service under warranty. Surface transportation charges for the return of the applicator to the customer shall be paid by THARO SYSTEMS within the 48 contiguous states and the District of Columbia. Customer shall pay shipping costs, customs clearance, and other related charges outside the designated area. If THARO SYSTEMS determines that the Product returned to it for warranty service or replacement is not defective as herein defined, BUYER shall be subject to a minimal labor charge and all costs of handling and transportation.

### 2. Warranty Exclusions and Conditions

The above warranties are in lieu of all other warranties, expressed or implied, oral or written, statutory or otherwise, including any implied warranty of merchantability or fitness for a particular purpose.

THARO SYSTEMS shall not be responsible for the specific application to which any Products are applied, including but not limited to compatibility with other equipment.

All statements, technical information and recommendations relating to THARO Products are based upon tests believed to be reliable but do not constitute a guarantee or warranty.

---

THARO SYSTEMS SHALL NOT, UNDER ANY CIRCUMSTANCES WHATSOEVER, BE LIABLE TO BUYER OR ANY OTHER PARTY FOR LOST PROFITS, DIMINUTION OF GOODWILL OR ANY OTHER SPECIAL OR CONSEQUENTIAL DAMAGES WHATSOEVER WITH RESPECT TO ANY CLAIM HEREUNDER. IN ADDITION, THARO SYSTEMS' LIABILITY FOR WARRANTY CLAIMS SHALL NOT, IN ANY EVENT, EXCEED THE INVOICE PRICE OF THE PRODUCT CLAIMED DEFECTIVE, NOR SHALL THARO SYSTEMS BE LIABLE FOR DELAYS IN REPLACEMENT OR REPAIR OF PRODUCTS

---

No salesperson, representative or agent of THARO SYSTEMS is authorized to make any guarantee, warranty, or representation in addition to the foregoing warranty.

---

NO WAIVER, ALTERATION, ADDITION, OR MODIFICATION OF THE FOREGOING WARRANTIES SHALL BE VALID UNLESS MADE IN WRITING AND SIGNED BY AN EXECUTIVE OFFICER OF THARO SYSTEMS

---