



# THARO H-Series Users Manual



## **FCC COMPLIANCE STATEMENT FOR AMERICAN USERS**

This equipment has been tested and found to comply with the limits for a CLASS A digital device, pursuant to Part 15 of the FCC Rules. These limits are designed to provide reasonable protection against harmful interference when the equipment is operated in a commercial environment. This equipment generates, uses, and can radiate radio frequency energy and, if not installed and used in accordance with the instructions, may cause harmful interference to radio communications. Operation of this equipment in a residential area is likely to cause harmful interference in which case the user will be required to correct the interference at his expense.

## **EMS AND EMI COMPLIANCE STATEMENT FOR EUROPEAN USERS**

This equipment has been tested and passed with the requirements relating to electromagnetic compatibility based on the standards EN50081-1 (EN55022 CLASS A) and EN61000-4-2/-3/-4/-5/-6/-8/-11 (IEC Teil 2,3,4). The equipment also tested and passed in accordance with the European Standard EN55022 for both the Radiated and Conducted emissions limits.

### **CAUTION**

Danger of explosion if battery is replaced incorrectly.

Only replace battery with an equivalent type as recommended by the manufacturer.

Dispose of used batteries according to the manufacturer's instructions.

## **Copyright and Trademark Notice**

© 2005 by Tharo Systems, Inc.

**It is illegal to photocopy or electronically transmit a facsimile of this manual or any portion of its contents for any means or purpose without the publisher's permission. Fines of up to \$10,000.00 may be imposed for violation.**

All brand or product names are trademarks or registered trademarks of their respective companies.

# TABLE OF CONTENTS

<b>1. PRODUCT DESCRIPTION</b> .....	<b>5</b>
General Information.....	5
Printer Options.....	5
Technical Specifications .....	6
<b>2. GENERAL SAFETY TIPS</b> .....	<b>7</b>
<b>3. UNPACKING THE PRINTER AND ACCESSORIES</b> .....	<b>7</b>
<b>4. IDENTIFYING COMPONENTS</b> .....	<b>8</b>
<b>5. PRINTER SETUP</b> .....	<b>10</b>
<b>6. CONTROL PANEL</b> .....	<b>11</b>
General Description and Operation .....	11
Setting Mode .....	11
Menu items and available options in Setting Mode .....	12
Interpreting LCD/LED Messages.....	14
<b>7. LOADING MEDIA</b> .....	<b>15</b>
Ribbon Out .....	15
Ribbon Installation .....	15
Label Installation .....	17
Activating the Stripper Sensor.....	18
<b>8. INSTALLING THE PRINTER'S OPTIONAL ACCESSORIES</b> .....	<b>19</b>
Internal Rewind Module Components.....	19
Internal Rewind Module Installation Instructions.....	20
Cutter Module Components.....	21
Cutter Module Installation Instructions .....	21
<b>9. USING THE PRINTER WITH A PS/2 KEYBOARD</b> .....	<b>23</b>
Entering/Exiting Keyboard Mode.....	23
Menu Items and Options available in Keyboard Mode.....	24

<b>APPENDIX A. COMMUNICATION INTERFACES.....</b>	<b>26</b>
Parallel Interface.....	26
Serial Interface.....	26
USB Interface.....	27
Installation of the USB HS Serial Converter.....	27
Removing the USB HS Serial Converter.....	29
PS/2 Interface.....	29
<b>APPENDIX B. ERROR MESSAGES / TROUBLESHOOTING .....</b>	<b>30</b>
Self Test.....	30
Dump Mode.....	30
LCD Error and LED Light Message Descriptions.....	31
Problems and Recommended Solutions.....	32
<b>APPENDIX C. MAINTENANCE AND ADJUSTMENT .....</b>	<b>33</b>
Cleaning the Thermal Printhead.....	33
Thermal Printhead Replacement.....	34
Thermal Printhead Print Line Adjustment.....	35
Thermal Printhead Spring Box Position/Pressure Adjustment .....	37
Ribbon Tension Adjustment .....	37
Drive Roller Replacement.....	38
Auto Sensing.....	40
Upgrading the Printer's Firmware.....	40
Clearing Cutter Jams.....	40
Cleaning Adhesive from the Cutter Blade.....	41

## Warranty Information

The THARO H-426/H-434 printers are warranted against defects in material or workmanship for 12 months (365 days) from the date of original shipment by THARO SYSTEMS, INCORPORATED. This warranty does not cover normal wear and tear and shall be null and void if the equipment is modified, improperly installed or used, damaged by accident or neglect, or in the event any parts are improperly installed or replaced by the user.

Since printhead wear is part of normal operations, a printhead warranty of 3 months (90 days) from the date of original shipment by THARO SYSTEMS, or 2,000,000 linear inches of use, whichever comes first. To qualify for this warranty, the printhead must be returned to THARO or another authorized service center. Although the user is not required to purchase THARO brand supplies (media and/or ribbons), to the extent it is determined that the use of other supplies (media and/or ribbons) shall have caused any defect in the thermal printhead for which a warranty claim is made, the user shall be responsible for THARO's customary charges for labor and materials to repair such defect. To the extent that it is determined that failure to follow the preventive maintenance schedule and procedures listed in the User Guide shall have caused any defect in the thermal printhead for which a warranty claim is made, this limited warranty shall be void. Any printhead returned to THARO with scratches or abrasions on the printhead at the point of failure will be deemed abused and no warranty replacement will be provided.

THARO SYSTEMS' SOLE OBLIGATION UNDER THIS WARRANTY SHALL BE TO FURNISH PARTS AND LABOR FOR THE REPAIR OR REPLACEMENT OF PRODUCTS FOUND TO BE DEFECTIVE IN MATERIAL OR WORKMANSHIP DURING THE WARRANTY PERIOD.

As a condition of this warranty, the user must: (a) obtain a THARO Return Authorization for the printer, or subassembly(s); (b) ship the printer or subassembly(s), transportation prepaid to the authorized service location; and (c) include with the Product or subassembly(s) a written description of the claimed defect. Unless THARO SYSTEMS authorizes return of the entire Product, the user shall return only the subassembly(s). Products returned shall be packaged in the original packing and shipping container or comparable container. In the event equipment is not so packaged or if shipping damage is evident, it will not be accepted for service under warranty. Surface transportation charges for the return of the printer to the customer shall be paid by THARO SYSTEMS within the 48 contiguous states and the District of Columbia. Customer shall pay shipping costs, customs clearance, and other related charges outside the designated area. If THARO SYSTEMS determines that the Product returned to it for warranty service or replacement is not defective as herein defined, BUYER shall be subject to a minimal labor charge and all costs of handling and transportation.

## Warranty Exclusions and Conditions

The above warranties are in lieu of all other warranties, expressed or implied, oral or written, statutory or otherwise, including any **implied warranty of merchant-ability or fitness for a particular purpose**.

THARO SYSTEMS shall not be responsible for the specific application to which any Products are applied, including but not limited to compatibility with other equipment.

All statements, technical information and recommendations relating to THARO Products are based upon tests believed to be reliable but do not constitute a guarantee or warranty.

THARO SYSTEMS SHALL NOT, UNDER ANY CIRCUMSTANCES WHATSOEVER, BE LIABLE TO BUYER OR ANY OTHER PARTY FOR LOST PROFITS, DIMINUTION OF GOODWILL OR ANY OTHER SPECIAL OR CONSEQUENTIAL DAMAGES WHATSOEVER WITH RESPECT TO ANY CLAIM HEREUNDER. IN ADDITION, THARO SYSTEMS' LIABILITY FOR WARRANTY CLAIMS SHALL NOT, IN ANY EVENT, EXCEED THE INVOICE PRICE OF THE PRODUCT CLAIMED DEFECTIVE, NOR SHALL THARO SYSTEMS BE LIABLE FOR DELAYS IN REPLACEMENT OR REPAIR OF PRODUCTS

No salesperson, representative or agent of THARO SYSTEMS is authorized to make any guarantee, warranty, or representation in addition to the foregoing warranty.

NO WAIVER, ALTERATION, ADDITION, OR MODIFICATION OF THE FOREGOING WARRANTIES SHALL BE VALID UNLESS MADE IN WRITING AND SIGNED BY AN EXECUTIVE OFFICER OF THARO SYSTEMS.

# 1. Product Description

## General Information

The THARO H-426 and H-434 Printers are heavy duty, high performance thermal transfer/direct thermal label Printers suitable for large volume printing requirements in industrial applications. With robust metal outer casing and inner mechanism, the Printers are designed to be durable, tough and reliable, even in the harshest environments.

The THARO H-426 features a printhead density of 8 dots/mm (203 dots/in) and a maximum print length of 1270mm (50"). The THARO H-434 features a printhead density of 12 dots/mm (300 dots/in) and a maximum print length of 558.8mm (22").

Both Printers provide high-speed performance of up to 6 inches per second with an 8" diameter label roll and 450 meter length ribbon capacities for large volume throughput. The THARO H-426 and H-434 feature a large, backlit LCD that is easy to read and is capable of displaying either text or graphics, making operation easy. A Real-Time Clock for time and date stamping of labels is standard on the H-426 and H-434. Also standard on the THARO H-426 and H-434 Printers is a Stripper Sensor to sense the presence of printed labels. With the Stripper Sensor activated, application software such as EASYLABEL® can operate the Printers in Peel-Off or Tear-Off modes.

The THARO H-426 and H-434 Printers provide internal memory for storing downloaded label formats, graphics, and fonts. Data can be downloaded to this memory via the Printers' serial interfaces. Using this memory the Printers can be operated **without** being connected to a computer, which represents a great advantage regarding their flexibility.

Accessories available for the THARO H-426 and H-434 Printers include a Cutter for ticket or receipt printing applications and the Internal Rewind to be used with the standard Stripper Sensor in strip-and-peel applications.

## Printer Options

### Internal Rewind

The Internal Rewind can be used with the Stripper Sensor to rewind the label liner when the Printer is operating in strip-and-peel mode. Its unique design incorporates a maximum liner switch that will stop the Printer from printing when the liner diameter exceeds 110mm (4.33").

### Cutter

The optional Cutter can be used to cut labels or tag stock up to a 10-mil thickness. Cutter options include a choice of: cut after each label, cut after a specific quantity of labels or cut at the end of a print job.

### 2MB FLASH memory module

The Printer has the ability to use internal Flash memory for storing downloaded label formats, graphics and fonts. This option provides an additional 2MB of memory above and beyond the 2MB that is standard in the Printer. This increases the available space for the storage of these files.

### External Keyboard

The PS/2 Keyboard connector allows you to connect your Printer to any standard PS/2 Keyboard. This will allow you to input variable data to a label format stored in Flash memory.

### EASYLABEL® - Label Design Software for Windows

EASYLABEL® labeling software allows you to drive your Printer and create a full range of label formats with a minimum of effort. EASYLABEL can be installed under Microsoft Windows® on IBM PCs and compatibles. For further information about EASYLABEL, please contact your THARO Reseller.

## Technical Specifications - Specifications are subject to change without notice.

Model	THARO H-426	THARO H-434
<b>Resolution</b>	8 dots/mm (203dpi)	12 dots/mm (300dpi)
<b>Print Mode</b>	Thermal Transfer/Direct Thermal	Thermal Transfer/Direct Thermal
<b>Printer CPU</b>	16 Bit Processor	
<b>Sensor Location</b>	Moveable, left aligned	
<b>Sensor Type</b>	Reflective, Transmissive	
<b>Sensor Detection</b>	Type: Label gap and black mark sensing Detection: Label length auto sensing and/or program command setting	
<b>Print Speed</b>	50.8mm (2")/sec ~ 152.4mm (6")/sec	50.8mm (2")/sec ~ 101.6mm (4")/sec
<b>Print Length</b>	5mm (0.20") ~ 1270mm (50")	5mm (0.20") ~ 558.8mm (22")
<b>Print Width</b>	5mm (0.20") ~ 104mm (4.09")	5mm (0.20") ~ 105mm (4.13")
<b>Media</b>	Label Roll: Max. 203mm (8") O.D. Core Diameter: 38.1mm (1.6") ~ 76.2mm (3") Width: 25.0mm (1") ~ 118.0mm (4.65") Thickness: 0.06mm (0.002") ~ 0.25mm (0.009")	
<b>Ribbon</b>	Material: Thermal Transfer ribbons (wax, resin and wax/resin) Type: Ink inside or ink outside Length: 450m (1471') Width: 30mm (1.18") ~ 110mm (4.33") Inner Core Diameter: 25.4mm (1") Ribbon Roll Diameter: 75mm (2.95")	
<b>Printer Language</b>	TPL (Tharo Programming Language)	
<b>Software</b>	Application: <b>EASYLABEL</b> ® Start Driver: Microsoft Windows 95, 98, ME, NT 4, 2000 and XP	
<b>Resident Fonts</b>	9 resident alphanumeric fonts (including OCR A & B) that are available in 4 orientations (0°, 90°, 180°, 270°), 8-point sizes (6, 8, 10, 12, 14, 18, 24, 30), and are expandable 8 times horizontally and vertically.	
<b>Downloadable Fonts</b>	Windows Bit-map fonts and Asian fonts are downloadable. Windows fonts in 4 orientations (0°, 90°, 180°, 270°). Asian fonts in 8 orientations.	
<b>Image Handling</b>	BMP and PCX	
<b>Bar Codes</b>	Code 39, Code 93, Code 128 (subset A, B, C), UCC 128, UPC A, UPC E, UPC 2 & 5 digit add on, I 2 of 5, EAN 8, EAN 13, EAN 2 & 5 digit add on, Codabar, Postnet, EAN 128, DUN 14, MaxiCode, PDF417, and DataMatrix	
<b>Interfaces</b>	Serial, Parallel, USB, PS/2 keyboard	
<b>Serial Interface Transmission Speed</b>	Baud rate 300 ~ 115200, XON/XOFF, DSR/DTR	
<b>Memory</b>	Built-In: 2MB Flash, 2MB DRAM    Optional: An additional 2MB of Flash	
<b>LCD Display</b>	Backlit Graphic LCD Display Three bi-color LED lamps: Power, Ready, Error Three Control keys: Feed, Pause, Cancel	
<b>Power</b>	110/240VAC, 50/60 Hz	
<b>Real-Time Clock</b>	Time and Date stamp	
<b>Environment</b>	Operation: 5°C to 40°C (40°F to 104°F) Storage: -20°C to 50°C (-40°F to 122°F)	
<b>Humidity</b>	Operation: 30-85%, non-condensing. Free air. Storage: 10-90%, non-condensing. Free air.	
<b>Agency Listings</b>	CE, CUL, FCC Class A	
<b>Printer Dimensions</b>	Length: 454.58mm (17.9") Height: 277.30mm (10.92") Width: 275.55mm (10.85") Weight: 13Kg (28.7lbs)	
<b>Options</b>	Cutter with Tray Internal Rewind 2MB Flash memory module Stand-alone keyboard	

## 2. General Safety Tips



### CAUTION!

- During the print process the printhead will become hot. Do NOT attempt to clean the printhead until it has had time to cool.
- The Printhead is the Most Fragile part of your Printer. Do NOT use sharp or hard objects to clean the Printhead. Do NOT touch the glass surface of the Printhead with your hand.
- This Printer is built exclusively to print labels, tickets and tags, continuous paper, etc. Only use media that is recommended for a direct thermal or thermal transfer Printer.
- The Printer is configured for input voltages of 110 to 240 V. Connect only to a power outlet with a grounded contact. Always ensure the Printer is switched OFF before connecting the power cord to an electrical outlet.
- Do not expose the Printer to moisture or operate it in wet or damp areas.
- The Printer will operate with the cover open if necessary. This is not recommended, as the Printer's moving or rotating parts can cause injury. Keep long hair, jewelry and loose clothing away from any moving parts.
- Remove the power cord from the rear of the Printer when disconnecting or attaching accessories such as rewind units, cutters, etc.

## 3. Unpacking the Printer and Accessories

Check the condition of the packaging and contents for possible damage during transit.



**NOTICE: Please retain original boxes and all original packing materials in case the Printer must be returned.**

In addition to this manual the following items should be included with your Printer:

- Bar Code Printer
- Power Cord (110V or 230V)
- Empty Ribbon Roll
- Quick Start Guide
- Accessories CD: Includes Label Software, Manuals and Windows Drivers

The following additional items are necessary for generating labels from your Printer:

- Serial, Parallel, or USB cable
- Applicable media (label stock/ribbon)



## 4. Identifying Components

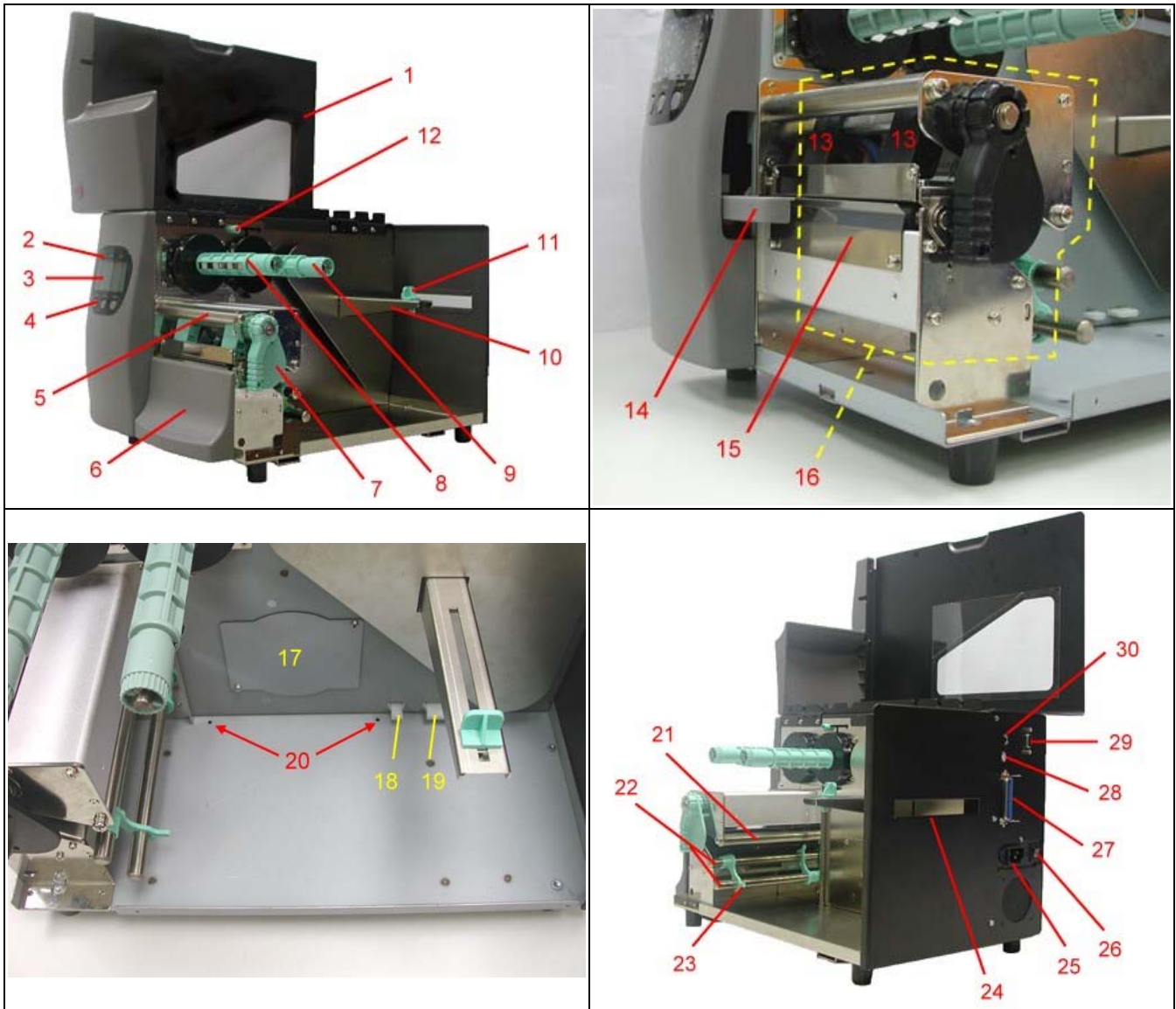

1	Top Cover	11	Label Width Guide	21	Ribbon Feed Rod
2	Indicator Light	12	Ink Position Lever	22	Label Feed Rods
3	Liquid Crystal Display (LCD)	13	Printhead Spring Box	23	Label Feed Guide
4	Control Keys	14	Stripper Sensor	24	Fan-Fold Label Slot
5	Ribbon Rod	15	Tear-Off Bar	25	Power Socket
6	Bottom Front Cover	16	Printer Mechanism	26	Power Switch
7	Printhead Lever	17	Rewind Option Cover Plate	27	Parallel Port
8	Ribbon Rewind Shaft	18	Rewind Connector	28	USB Port
9	Ribbon Supply Shaft	19	Cutter Connector	29	Serial Port
10	Label Roll Bar	20	Cable Configuration Holes	30	PS/2 Port

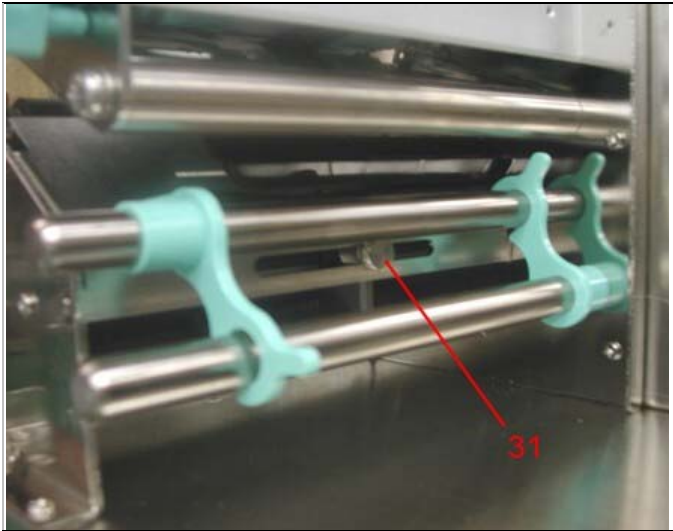

31	Moveable Sensor Lever	32	Sensor Position Mark	33	Moveable Sensor
----	-----------------------	----	----------------------	----	-----------------

## 5. Printer Setup



### CAUTION!

When choosing a location for the Printer, ensure that the Printer and operator remain dry. If the Printer or the operator get wet, serious injury to the operator or damage to the Printer may occur.



### CAUTION!

Make sure that the Printer's power switch is in the "0" or "Off" position before proceeding with the installation.

1. Plug the supplied power cord into the Printer's power socket.
2. Plug the other end of the power cord into a grounded outlet.
3. Select the correct cable for the chosen interface. The Printer can be directly connected to the PC in one of 3 ways: USB, parallel, or serial. For the connection to the USB port use a suitable USB cable. For the connection to the PC's parallel port use a suitable parallel interface cable. If the serial interface is used make sure the proper serial cable is used. You can find pin assignments and descriptions for all three interfaces connectors in Appendix A.



### NOTICE!

For Serial communications make sure that the "COM Port Setup Options" in the Printer's front panel are configured the same as the software you will be using with the Printer.



### NOTICE!

If you wish to connect the Printer to the computer using the USB interface, you must install the "USB HS Serial Converter". (See 'Appendix A. Communication Interfaces' for more details.)

4. Connect the Printer to the computer with the selected cable. Then secure the cable using any screws or clips attached to the connectors. These prevent the connection from working loose.
5. Turn the Printer on, the LCD will show the Printer model and firmware version.

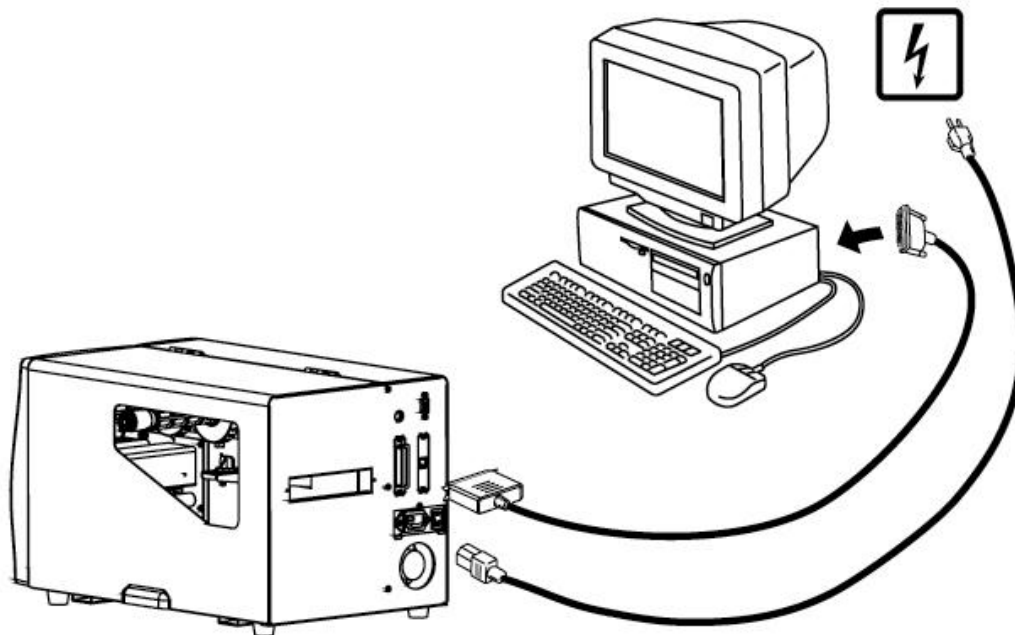

## 6. Control Panel

### General Description and Operation

#### Pause Key

Pressing the Pause key when the Printer is in Standby Mode will put the Printer in Pause Mode and the LCD will display "H-xxx Hx.xxx Pause". When the Printer is in Pause it will not receive any commands. Pressing the Pause key again will take the Printer out of Pause and put it back in Standby Mode.

Pressing the Pause key while the Printer is printing will pause the current print job. Pressing the Pause key again will take the Printer out of Pause and the Printer will continue with the rest of the print job. For example, if the print job contains 10 labels and the Pause key is pressed after 2 labels are printed, the Printer will stop printing the job. When the Pause key is pressed again, the Printer will resume printing the remaining 8 labels.

#### Cancel Key

Pressing the Cancel key while the Printer is printing will cancel the job. The LCD will display "xxxxxxx Cancel" this confirms the job has been cancelled. For example, if the print job contains 10 labels and the Cancel key is pressed after 2 labels are printed the Printer will stop printing labels and the remaining 8 labels will not be printed.

#### Feed Key

Pressing the Feed key will cause the Printer to advance the media (according to media type) to a specified stop position. If the Printer is loaded with continuous media the Printer will feed the media out a certain length. If the Printer is loaded with labels with gaps or black marks, the Printer will advance one label at a time. If the label is not sent out in a correct position the sensor must be calibrated. Follow the instructions for Sensor Calibration in the Maintenance and Adjustment section of this manual.

### Setting Mode

In Setting Mode you are able to change the various settings that control the operation of the Printer such as: printing mode, options, media type, interface options, and language display.

1. To enter Setting Mode: Press and hold the "Pause" key and "Feed" key until the LCD shows "Setting Mode."
2. Release the keys and you are now in "Setting Mode." The first option will be displayed on the LCD.
3. In Setting Mode, the control keys have the following functions:

**Feed Key: Select or scroll through the available selections**

**Pause Key: Enter or confirm**

**Cancel Key: Exit**

4. Current settings are displayed in **highlighted** text on the LCD.
5. Before exiting Setting Mode, the Printer will prompt the user if the settings should be saved or not.
6. After user's response, on whether or not to save the settings, the Printer will return to Standby Mode.

## Menu items and available options in Setting Mode



### NOTICE!

"Default Setting" is the value of the setting as delivered from the factory. Any changes made in Setup Mode are saved after the Printer is turned off.

<b>Printing Mode</b>	<p><b>Thermal Transfer:</b> when printing, a ribbon must be installed to transfer the print contents onto the media.</p> <p><b>Direct Thermal:</b> when printing, no ribbon is necessary; it only requires direct thermal media.</p>
<b>Option Setup</b>	<p><b>Strip Mode:</b> turns the Stripper Sensor on</p> <p><b>Cutter Mode:</b> turns the Cutter on</p> <p><b>Option OFF:</b> turns off the Stripper Sensor or Cutter. This is the default setting.</p> <p><b>Applicator:</b> Sets printer to be used with an applicator or foot switch.</p>
<b>Paper Setup</b>	<p><b>Black Mark:</b> for label or plain paper with black mark on the back.</p> <p><b>Gap Paper:</b> for labels with liner and gap, or hang tags. The default is set to be gap paper.</p> <p><b>Plain Paper:</b> continuous media without gaps or sensing marks.</p>
<b>COM Port Setup</b>	<p><b>Baud Rate:</b> 4800/ 9600/ 19200/ 38400 /57600 /115200 bps, default: 9600</p> <p><b>Parity Set:</b> None / Odd / Even, default: None</p> <p><b>Data Length:</b> 7 / 8 bits, default: 8 bits</p> <p><b>Stop bit:</b> 1 / 2 bits, default: 1 bit</p>
<b>Auto Sensor</b>	<p><b>Auto Mode:</b> automatically senses and sets the label type (black mark, gap or plain paper) and length</p> <p><b>Gap Mode:</b> detects label stock with gaps</p> <p><b>Black Mode:</b> detects label stock with black marks</p>
<b>LCD Language</b>	<p>English</p> <p>Simplified Chinese</p> <p>Traditional Chinese</p> <p>Spanish</p> <p>Italian</p> <p>German</p> <p>French</p> <p>Turkish</p>
<b>Code Page Setup</b>	<p>Code Page 850, Code Page 852</p>
<b>Keyboard Setup</b>	<p>US International</p> <p>United Kingdom</p> <p>French</p> <p>German</p> <p>Spanish</p> <p>Italian</p> <p>Finnish</p> <p>Dutch</p> <p>Belgian</p>
<b>Keyboard Mode</b>	<p>Pressing Enter allows the user to use a keyboard connected to the Printer for stand-alone printing. (This is the same as connecting the keyboard to the Printer and then pressing the 'Y' key.)</p>
<b>Buzzer Setup</b>	<p><b>On:</b> The printer will sound the buzzer (beep) as a confirmation of most events.</p> <p><b>Off:</b> The printer will only sound the buzzer (beep) when there is a condition that requires the operator's attention.</p>

<b>Smart Backfeed</b>	<p>When in stripper or cut mode, a label is printed and moved forward to be cut or peeled off. If Smart Backfeed is ON, the next label will be partially printed so the printer does not have to backfeed to find the original starting point when printing continues.</p> <p><b>On:</b> Turns smart backfeed on  <b>Off:</b> Turns smart backfeed off. (default)</p>
<b>Printhead position</b>	<p>Defines the location of the print image on the label.  Range is -100 to +100 (hundredths of inches) (-.254mm - .254mm)  Positive values cause the print image to be moved to the trailing edge of the label.</p>
<b>Password</b>	<p><b>On:</b> Allows user to set a password to restrict setup changes.  <b>Off:</b> Allows any user to change setup selections. (default).</p>
<b>Preview</b>	<p>Selecting "Preview" allows the user to browse the current configuration settings on the LCD. Pressing the Feed Key will allow the user to scroll through the list of configuration options.</p>

## Interpreting LCD/LED Messages





LCD Display	LED Light			Beep	Description
	Power	Ready	Error		
Model Name Hx.xxx	Green	Green		1	H-xxx: Printer model; Hx.xxx: current firmware version.
Self-Test	Green	Green		3	Printer is in Self-Test Mode. Refer to Appendix B for more information.
Now in Dump Mode	Green	Green		3	Printer is in Dump Mode. Refer to Appendix B for more information.
Auto Sensing Mode	Green			3	Printer is in Auto-Sensing Mode. Please refer to Appendix C for more information.
Model Name Pause	Green	Green			Printer has paused, press Pause key again to continue printing.
Print job is cancelled	Green	Green			Cancel key pressed, stops all print jobs and clears the Printer.
Press Feed key to continue print job	Green		Red		Press the Feed key to allow Printer to continue with the current print job.
PROGRAM LOADING	Green		Red (Flash)		Printer is downloading the firmware.
LOADING COMPLETE	Green	Green		1	Firmware has been successfully downloaded.
Setting Mode	Green	Green		1	Printer is currently in the Setting Mode. Please see the Setting Mode section for more information.

## 7. Loading Media

### Ribbon Out

If the ribbon runs out during a print job, the Printer will beep four times and the Red error light will glow. An "Out of ribbon or check ribbon sensor" message will be displayed on the Printer's front panel. Replace the ribbon by following the instructions in this manual. Press the Feed key to resume printing.

### Ribbon Installation

<p>1. Open the Printer's top cover.</p>	 A photograph of a printer with its top cover open. A red arrow points to the top cover, indicating it should be lifted.
<p>2. Pull the Printhead Lever out and rotate it upward to the right (counterclockwise) to open the Thermal Printhead.</p>	 Two photographs showing the printhead lever. The left photo shows a hand pulling the lever out, with a red arrow pointing right. The right photo shows the lever being rotated upwards and to the right, with a red arrow indicating the rotation and a blue arrow pointing from the left photo to the right one.
<p>3. Remove the used ribbon from the Ribbon Rewind Shaft. Remove the empty ribbon core from the Ribbon Supply Shaft.</p> <p>4. Place the new ribbon roll onto the Ribbon Supply Shaft.</p> <p>5. Place the empty ribbon core onto the Ribbon Rewind Shaft.</p>	 A close-up photograph of the printer's internal ribbon mechanism, showing the ribbon supply shaft and the ribbon rewind shaft.
<p>6. Feed the ribbon from the Ribbon Supply Shaft Rod under the Printhead. Be sure that the ribbon is not fed under the Moveable Sensor.</p>	 A close-up photograph of the printer's internal ribbon mechanism. A red arrow points to the ribbon being fed under the printhead, and another red arrow points to the moveable sensor, indicating that the ribbon should not be fed under it.



7. Wrap the ribbon around the Ribbon Shaft Rod making sure that the ribbon rewind direction is correct.



8. Ribbon outside (ink outside the roll).

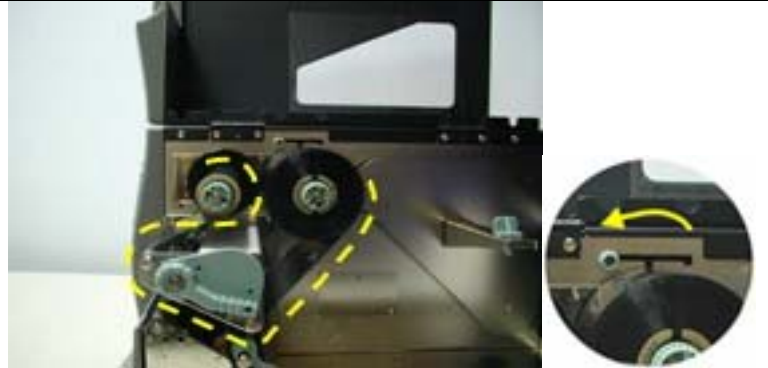

9. Ribbon inside (ink inside the roll).



10. Attach the end of the ribbon to the empty ribbon core using adhesive tape or part of a label.



11. Rotate the Printhead Lever clockwise back to its original position making sure it snaps into place.

12. Close the top cover to complete the ribbon installation.



# Label Installation

1. Open the Printer's top cover.



2. Slide the roll of label stock onto the Label Roll Bar all the way back to the Printer's inner wall.

3. Slide the Label Width Guide in until it rests against the label stock. Avoid pushing the guide in too far or you will damage the edge of the label stock.



4. Pull the Printhead Lever out and rotate it up and to the right (counterclockwise) to open the Thermal Printhead.

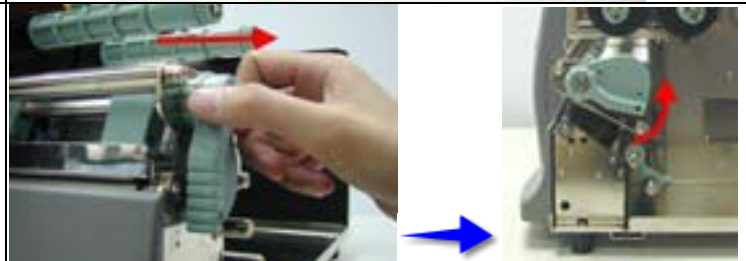

5. Slide the Outside Label Feed Guide to its outermost position and rotate it upward.

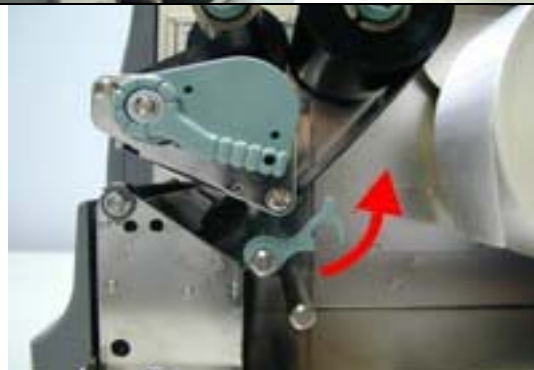

6. Feed the label stock through the two Label Feed Rods to the Tear-Off Bar. Make sure the label stock is fed under the Moveable Sensor.

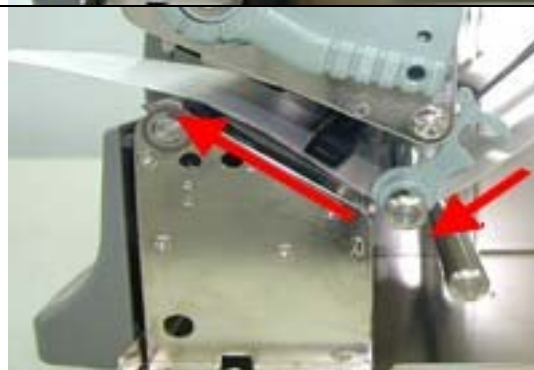

7. Slide the inside edge of the label stock inward against the Inside Label Feed Guide. Then, slide the Outside Label Feed Guide inwards until it contacts the outside edge of the label stock.
8. Rotate the Outside Label Feed Guide back down to its original position and clip the guide in position.

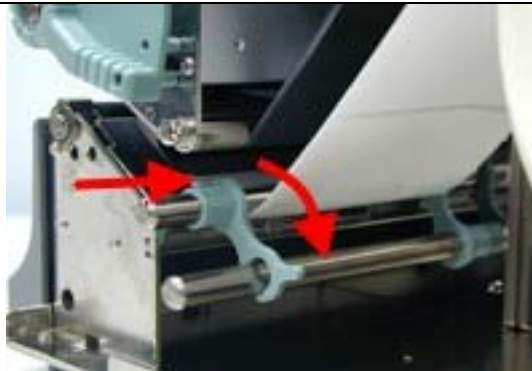

9. Rotate the Printhead Lever clockwise back to its original position making sure it snaps into place.
10. Close the top cover to complete the label installation.



## Activating the Stripper Sensor

The Stripper Sensor senses the presence of printed labels. With the Stripper Sensor activated, it is possible to operate the Printer in Tear-Off or Peel-Off (Strip-and-Peel) modes. See the "THARO H-Series Internal Rewind Module Installation Instructions" section in this manual for more information about setting the Printer up for Strip-and-Peel.

To set up the Printer to operate in Tear-Off mode:

1. Press the Stripper Sensor (D) to flip it open.
2. Correctly position the sensor and close the Top Cover of the Printer.
3. Turn the Stripper Sensor on in the Printer's Setup Mode.



### NOTICE!



**When the Printer's Stripper Sensor is activated, it blocks part of the Tear-Off Bar. This can be a problem if the printed labels will be torn off after they are printed. In this case it is recommended to use perforated label stock to make tearing off the printed labels easier.**

## 8. Installing the Printer's Optional Accessories

The Optional Internal Rewind or Cutter can be easily installed and configured in the field using only a number 2 Phillips screwdriver. This section will provide a component list and installation instructions for both of these optional accessories.



### CAUTION!

**Make sure that the Printer's power switch is in the "0" or "Off" position before proceeding with the installation.**



### CAUTION!

**Unplug the power cord from the Printer before performing any service on it. Failure to do so could result in personal injury or damage to the Printer!**

### THARO H-Series Internal Rewind Module Components

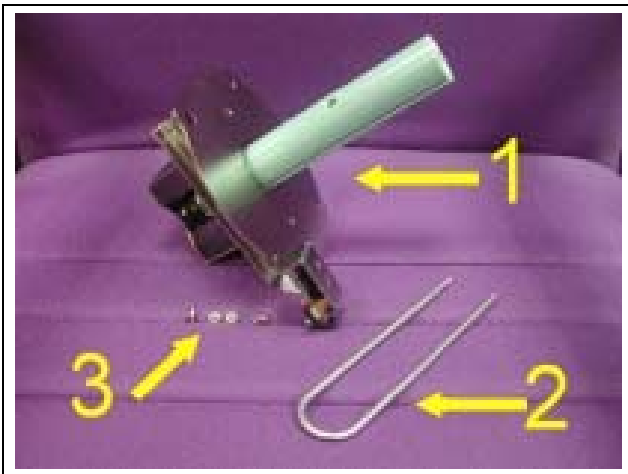

1. Internal Rewind Module
2. U-Shaped Metal Clip
3. Screws (M3X4.5) Qty. 4



### NOTICE!



**The Internal Rewind must be used with the Stripper Sensor. Make sure the Stripper Sensor is turned on in the Printer's Setup Mode before using the Internal Rewind.**



### NOTICE!

**When the diameter of the wound label liner reaches about 110mm (4.33") the liner will touch the maximum liner switch and the Printer will stop printing. The Printer will not resume printing until the used liner is removed.**

# THARO H-Series Internal Rewind Module Installation Instructions

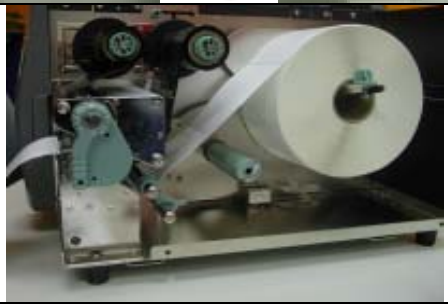
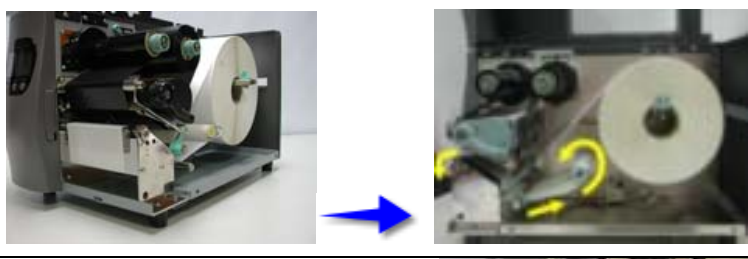
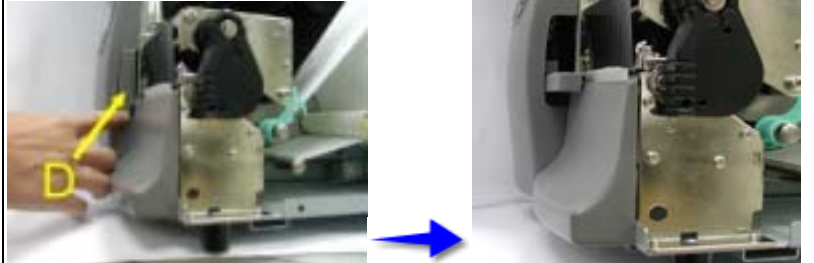
<ol style="list-style-type: none"> <li>1. Open the Top Cover of the Printer and turn the Printer sideways.</li> <li>2. Remove the 2 screws (E) for the rewind cover and then remove the rewind cover (C).</li> </ol>	
<ol style="list-style-type: none"> <li>3. Remove the U Shape Metal Clip (2) from the rewind shaft and then install the Internal Rewind module (1) using the 4 supplied screws (3).</li> </ol>	
<ol style="list-style-type: none"> <li>4. After installing the Internal Rewind Module (1), plug the cable connector onto the rewind control socket.</li> </ol>	
<ol style="list-style-type: none"> <li>5. Install ribbon and label stock in the Printer (refer to the "Loading Media" section in this manual).</li> </ol>	
<ol style="list-style-type: none"> <li>6. Peel off several labels to expose about 400mm (16") of liner. Then feed the liner between the Tear-Off Bar and the Bottom Front Cover.</li> <li>7. Wrap the liner around the Rewind Module (1), and use the U Shape Metal Clip (2) to secure the liner.</li> </ol>	
<ol style="list-style-type: none"> <li>8. Press the Stripper Sensor (D) to flip it open.</li> <li>9. Correctly position the Sensor and close the Top Cover of the Printer.</li> </ol>	

# THARO H-Series Cutter Module Components



1. Cutter Cover
2. Cutter Module and connector
3. Screws (M3X8), Qty. 2
4. Tray
5. Wire Saddles, Qty. 2

# THARO H-Series Cutter Module Installation Instructions

1. Face the front of the Printer and unscrew the Bottom Cover Screw (A). Carefully remove the Bottom Front Cover (B) DO NOT pull the cover with full force. Separate the hook clip from the bottom casing and gently lift the cover to remove.



2. Open the Top Cover, and remove the Tear-Off Bar (C) using a screwdriver.



3. Position the Cutter Module (2) and secure it onto the Printer by using the 2 supplied screws (3).



4. Plug the connector cable into the Cutter control socket (D).

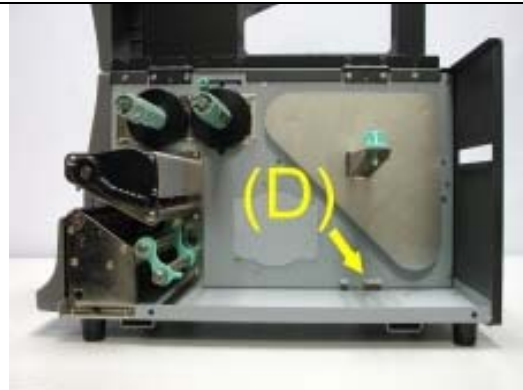
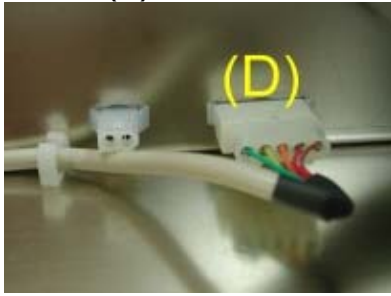

5. Place the Cutter cable into the Wire Saddles (6), and insert the Wire Saddles into the holes.



6. Position the Cutter Cover (1) over the Cutter Module, and use the Bottom Cover Screw (A) to secure the cover into place.

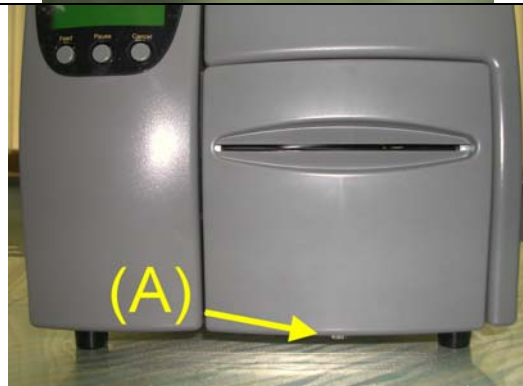

7. Insert the tabs of the Tray (4) into the mouth of the Cutter Cover (1).



8. Install ribbon and label stock in the Printer (refer to the "Loading Media" section in this manual). Close the Top Cover of the Printer to complete installation.



## 9. Using the Printer with a PS/2 Keyboard

### Entering/Exiting Keyboard Mode



**NOTICE!**

The location of keys on a keyboard can vary based on the language! Before connecting a keyboard please set the correct Keyboard Language in Setup. (See the section 'Menu items and available Options in Setting Mode'.)

The PS/2 interface can be used to connect a keyboard to the Printer for stand-alone printing without a computer attached. Once a format has been selected from memory, the LCD will prompt the user for the format's variable data and quantity to print. The user can use the keyboard to make these selections and enter the format's variable data. The LCD provides the user with feedback by displaying on the screen what has been typed. To enter Keyboard Mode:

1. Plug the connecting cable of a standard PS/2 keyboard into the PS/2 interface port on the back of printer.
2. The Printer will sense that a keyboard is present and will display "Enter Keyboard Mode [y/n]" on the LCD.
3. Press the "Y" key on the keyboard to enter Keyboard Mode.

While in Keyboard Mode you can press the **ESC** key to go back to the previous menu. To exit Keyboard Mode, press the **ESC** key until the LCD displays "Exit Keyboard Mode [y/n]". Press the "Y" key on the keyboard to exit Keyboard Mode or press the "N" key on the keyboard to continue in Keyboard Mode.



**NOTICE!**

You can also exit Keyboard mode by selecting "Exit KB Mode" from the Keyboard Mode menu selections on the front panel.

To re-enter Keyboard Mode, simply press the F1 key or cycle the power on the Printer with the keyboard still connected to the Printer's PS/2 port and press the "Y" key on the keyboard when the Printer displays "Enter Keyboard Mode [y/n]" on the LCD.



## Menu Items and Options available in Keyboard Mode

Once the Printer is in Keyboard Mode, the user will be presented with a menu. The user can navigate through the menu by using the Up and Down arrow keys on the keyboard. Menu selections are made by pressing the Enter key on the keyboard while the item is selected. The menu items and their functions are as follows:

### NOTICE!



The "Keyboard Setup" and "Code Page Setup" options are also in the Printer's Setting Mode menu. The values displayed for these two options will be taken from the Setting Menu and any changes made to these options will be reflected in the Setup Mode menu. (See the section 'Menu items and available Options in Setting Mode'.)

<b>Recall Label</b>	Allows the user to select a format to be printed from a list of all downloaded formats. Use the Up and Down arrows on the keyboard or press the first character of the format name on the keyboard to browse the list of stored formats and press the Enter key to select a format. The user will be prompted for any variable data and a quantity to print. If no formats have been downloaded the user will be presented with the message "No label format in memory..."
<b>Keyboard Setup</b>	US International United Kingdom French German Spanish Italian Finnish Dutch Belgian
<b>Code Page Setup</b>	Code Page 850, Code Page 852
<b>Clock Setup</b>	<i>Note: A keyboard must be used to set the time and date.</i> Allows user to display printer time or set Hours, Minutes, Seconds, Month, Date, Year and Day. When setting the clock, use the Enter key on the keyboard to move through the prompts. Use the Backspace key on the keyboard to delete the current setting. Then type in a new setting.
<b>Exit KB Mode</b>	Exits Keyboard Mode and puts the Printer back into Standby Mode.

## **Downloading to Flash Memory using EASYLABEL**

EASYLABEL formats can be downloaded to the H-Series printer's flash memory where the user will be able to print labels from the H-Series printer without a PC attached.

When creating a format in EASYLABEL, be sure the Memory Card Download option in the Format Specifications page is set to YES.

Be sure the printer is connected to the PC through the serial (COM) port.

After creating the format(s) that need to be sent to the printer, there are two ways to download formats to the printer.

### **Downloading a single format.**

1. At the Edit screen of EASYLABEL click the printer icon or click File | Print Batch of Formats from the menu.
2. The Print Request screen will appear. Click Cancel.
3. Click the Download Format to Memory Card icon or click Tools | Download Format to Memory Card.
4. A "Download Format to Memory Card" Window will appear where the user can make choices for downloading the format. After the selections have been made click the OK button.
5. "Data Receiving" will be displayed on the LCD screen of the printer.
6. A "Finished downloading format to the memory card" message box will be displayed after the download is complete. Click the OK button.

### **Downloading multiple formats.**

1. From EASYLABEL click File | Download Multiple Formats.
2. From the Browse Window select all formats that need to be downloaded to the flash memory and click the Open button.
3. Choose and click Yes or No at the Auto-Name Formats message box.
4. A "Download Format to Memory Card" Window will appear where the user can make choices for downloading the format. After the selections have been made click the OK button.
5. "Data Receiving" will be displayed on the LCD screen of the printer.
6. A "Finished downloading format to the memory card" message box will be displayed after the download is complete. Click the OK button.

# Appendix A. Communication Interfaces

## Parallel Interface

The Printers are equipped with a 36-pin Parallel interface connector. Any standard IBM PC compatible parallel cable can be used to connect to your Printer. In the event of any difficulties, the table listed below can be used to obtain a suitable cable.

PIN NO.	FUNCTION	TRANSMITTER
1	Strobe	Host
2-9	Data 0-7	Host
10	Acknowledge	Printer
11	Busy	Printer
12	Paper Empty	Printer
13	Select	Printer
14-15	N/C	
16	Signal Ground	
17	Chassis Ground	
18	+5V DC	
19-30	Signal Ground	
31	Init	
32	Fault	
33	Signal Ground	
34-36	Select	

## Serial Interface

The Printers are equipped with a 9-pin SUB-D connector to be used as a Serial interface.



### NOTICE!

**Make sure that the "COM Port Setup Options" in the Printer's front panel are configured the same as the software you will be using with the Printer.**

**Connector Type: DB9 female, pin assignment is as follows:**

PIN NO.	1	2	3	4	5	6	7	8*	9
FUNCTION	+5 V	TXD	RXD	N/C	GND	N/C	CTS	RTS	N/C

*\*Flow Control Line*

### Serial interface from PC to Printer

PC			Printer
---	1		+5V
RXD	2		TXD
TXD	3		RXD
DTR	4		N/C
GND	5		GND
DSR	6		N/C
RTS	7		CTS
CTS	8		RTS
---	9		N/C

## USB Interface

The Printer is equipped with a Type B USB connector that can be connected to any compatible USB port.

PIN NO.	1	2	3	4
FUNCTION	USBVC C	D-	D+	GND

## Installation of the USB HS Serial Converter

1. USB is a Plug & Play facility. Once the USB cable is connected from the PC to the Printer, the PC will automatically detect the new device and begin the installation process. You will see a "Building Driver Information Database" Window followed by the Add New Hardware Window.



2. Be sure the installation CD that you received with your Printer is in the CD drive of your PC. Select "Search for a suitable driver for my device [recommended]" and click "Next".



3. Select "Specify a location" as the location of the driver. (the drivers are in the USB\_Serial Converter Drivers directory on the CD). click "Next".

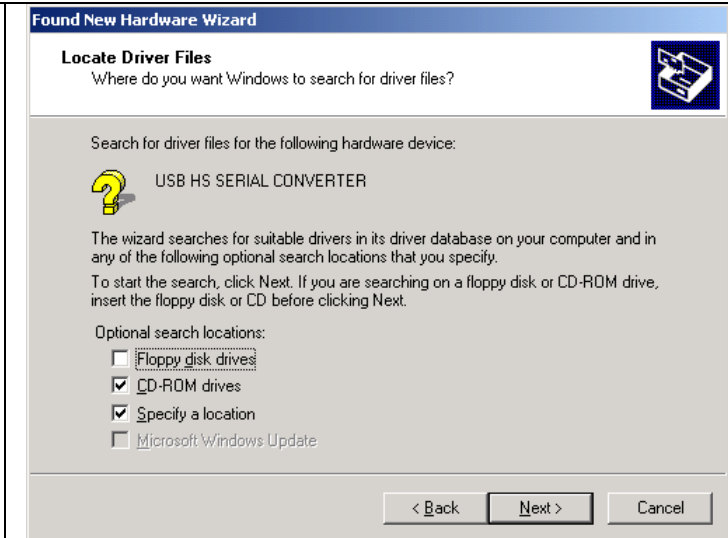

4. Once the USB device driver is located click "Next". The driver will be installed and the wizard will close.

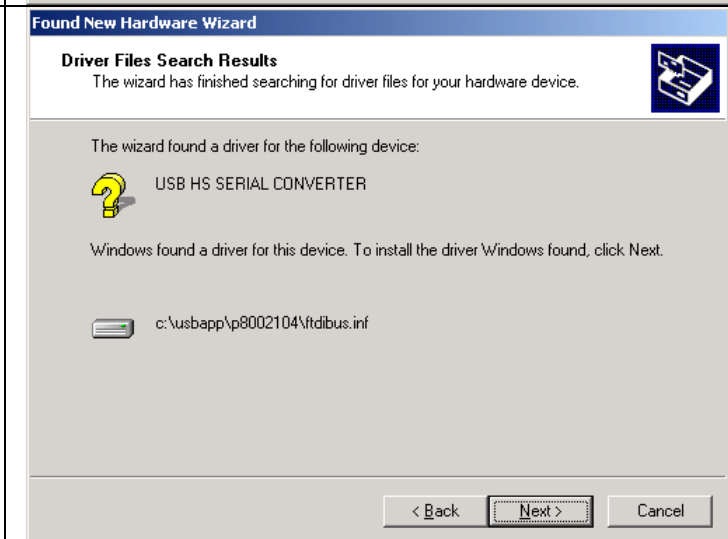

5. This USB device driver uses a virtual COM port that redirects any data sent to it out of the PC's USB port. It will be listed in Device manager as an additional COM Port.

6. Go to Control Panel\System\Device Manager and the USB device's port will be listed under Ports (COM & LPT). The example shown on the right indicates that the USB Serial Port is COM3.

7. After the USB device driver is installed, the USB device can be used through any software (such as EASYLABEL or Windows drivers) to print labels. In this example we would send any print job for this Printer to COM3.

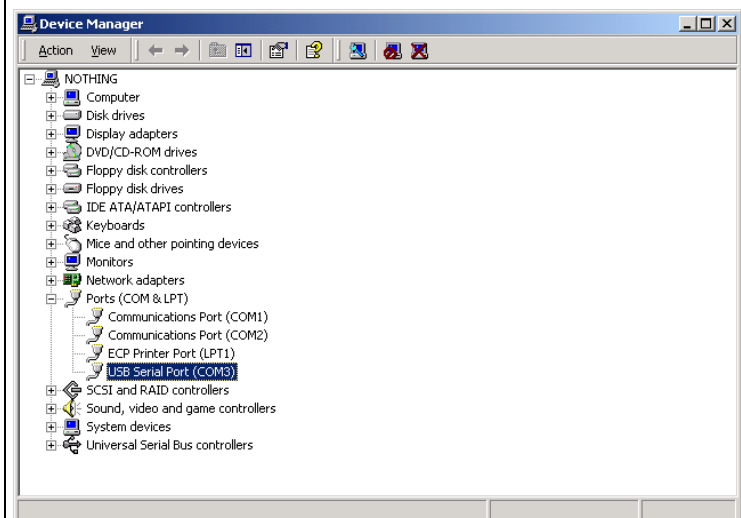

## Removing the USB HS Serial Converter

To remove the USB device driver, go to the Windows Control Panel and double click the Add/Remove Programs icon. Click on FTDI USB to Serial Converter Drivers in the program list and click the Add/Remove button. The message box on the right will appear. Click "Continue" to remove the USB device driver.



## PS/2 Interface

The PS/2 interface can be used to connect a keyboard to the Printer for stand-alone printing without a computer attached. (See section 9. Using the Printer with a PS/2 Keyboard.)

### PS/2 interface from keyboard to Printer

PC			Printer
DATA	1	1	DATA
N/C	2	2	N/C
GND	3	3	GND
VCC	4	4	VCC
CLOCK	5	5	CLOCK
N/C	6	6	N/C

# Appendix B. Error Messages / Troubleshooting

## Self Test

The Printer's Self Test function prints a Test Label every time the Feed Key is pressed. The Test Label consists of a test pattern and a variety of information about how the Printer is configured as well as its status.

To perform a Self Test:

1. Turn the Printer Off.
2. Press and hold the Feed key.
3. Turn the Printer On while still holding the Feed key down.
4. Release the Feed key after hearing 3 beeps.

After about 1 second the Printer will print the Test Label and the LCD will display "Self Test". This means the Printer is operating normally. Simply cycle the power on the Printer to exit the Self Test.

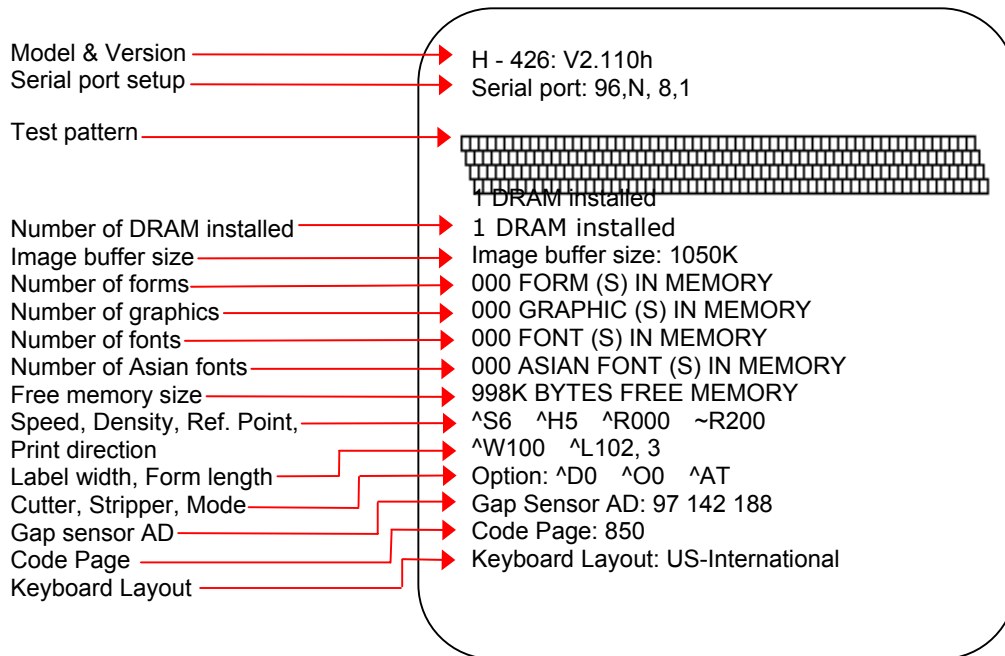

## Dump Mode

The Printer's Dump Mode provides the ability to print the command sequences received by the Printer instead of executing them. Dump Mode is very useful as a troubleshooting tool when the label settings and the print results do not match, and can be used to check for errors in data transmission between the Printer and the PC. Examining the Dump Mode print out will confirm whether or not the correct commands were received.

To enter Dump Mode:

1. Turn the Printer Off.
2. Press and hold the Feed key.
3. Turn the Printer On while still holding the Feed key down.
4. The Printer will beep three times. Continue to hold the Feed key down; the Printer will beep one more time.
5. When the LCD shows the message "DUMP MODE BEGIN" release the Feed key. The Printer will print "DUMP MODE BEGIN". The Printer is now in Dump Mode.
6. Send commands to the Printer and check to see if the commands printed are the same commands sent by your application.
7. Press the Feed key to exit Dump Mode. The Printer will print "OUT OF DUMP MODE" to confirm that it is no longer in Dump Mode.

## LCD Error and LED Light Message Descriptions

LCD Message Display	LED Message Light			Beeps	Description	Solution
	Power	Ready	Error			
Printhead is opened	Green		Red	4	The Printhead is not firmly in place.	Re-open the Printhead and make sure it closes tightly.
Entering the Cooling Process	Green		Red		Printhead temperature is too high.	Printer goes back to standby mode after cooling.
Out of ribbon or check ribbon sensor	Green		Red	3	No ribbon is installed and using Direct Thermal stock.	Make sure the Printer is in the Direct Thermal mode.
					The ribbon is used up or the Ribbon Supply Shaft is not moving.	Replace with new ribbon roll.
Out of media or check media gap sensor	Green		Red	2	The moveable sensor is unable to detect paper.	Make sure the movable sensor mark is at the correct position. If the sensor is still unable to detect the paper then go through Auto Sensing steps again.
					The label stock is used up or label sensor can't detect paper.	Replace with new roll of labels. If the moveable sensor is still not able to detect the paper then go through Auto Sensing steps again.
Check paper setting	Green		Red	2	Improper paper feed.	Possible causes: 1. Media falling into the gap behind the platen roller. 2. Can't find label gap/black mark. Perform Auto Sensing procedure. 3. Black mark paper out.
Command is not recognized	Green		Red	2	Wrong command.	Check Printer commands for possible errors or missing parameters.
Memory is full	Green		Red	2	Memory is full.	Delete unnecessary data in the memory or add the optional memory expansion module.
Filename can not be found	Green		Red	2	Can't find the file.	Use "~X4" command to print out all the files and check whether the file exists and if the name is correct.
Filename is repeated	Green		Red	2	Another file with this name exists.	Change the file name and download again.
No label format in memory	Green	Green		2	Trying to load a format from memory when none are saved.	Press Enter or ESC on the keyboard to clear the error and download a label format to memory before trying to print it.



### NOTICE!

**The Printer repeats all warning beeps. For example when the Printer's Printhead is opened, the Printer will beep four times, pause, and then beep four more times.**



## Problems and Recommended Solutions

Problem	Recommended Solution
LCD shows no message after switching the Printer on	<ul style="list-style-type: none"> <li>◆ Check the power cord</li> </ul>
LED light turns red (power/status) after printing stops	<ul style="list-style-type: none"> <li>◆ Check for software setting or program command errors</li> <li>◆ Check if labels or ribbon is out and replace with suitable labels or ribbon</li> <li>◆ Check if label stock is jammed</li> <li>◆ Check if Printhead Mechanism is closed (Printhead not positioned correctly)</li> <li>◆ Check if sensor is blocked by paper/label</li> <li>◆ If Cutter is installed check that it is working and working properly</li> </ul>
Printing started but nothing was printed on the label	<ul style="list-style-type: none"> <li>◆ Check that the ribbon is installed with the inked side facing the label media</li> <li>◆ Select the correct Printer driver</li> <li>◆ Select the correct label stock and print mode</li> </ul>
The labels jammed when printing	<ul style="list-style-type: none"> <li>◆ Clear the label jam and check that the Printhead is clean</li> </ul>
Only part of the label was printed	<ul style="list-style-type: none"> <li>◆ Check if label or ribbon is stuck on the Printhead</li> <li>◆ Check if application software has errors</li> <li>◆ Check if start position setting has errors</li> <li>◆ Check if ribbon has wrinkles</li> <li>◆ Check if Ribbon Supply Shaft is creating friction with the platen roller. If the platen roller needs to be replaced, please contact your Reseller for more information.</li> <li>◆ Check if power supply is within the voltage range</li> </ul>
Part of the label was not printed completely	<ul style="list-style-type: none"> <li>◆ Check if Printhead is dirty</li> <li>◆ Use internal command "~T" to perform a Test Print and check if the Printhead can print across its entire width</li> <li>◆ Check the media quality</li> </ul>
Printout not in desired position	<ul style="list-style-type: none"> <li>◆ Check if sensor is covered by paper or is dirty</li> <li>◆ Check if liner is suitable for use, please contact Reseller for more information</li> <li>◆ Check if label roll edge is aligned with Label Width Guide</li> </ul>
Labels are skipped while printing	<ul style="list-style-type: none"> <li>◆ Check if error occurs on label height setting</li> <li>◆ Check if the sensor is covered by paper or is dirty</li> </ul>
Smudged or blurry printout	<ul style="list-style-type: none"> <li>◆ Check print darkness setting</li> <li>◆ Check if Printhead is dirty</li> </ul>
The cutter did not cut straight	<ul style="list-style-type: none"> <li>◆ Check if label stock is installed correctly</li> </ul>
The cutter did not cut the label successfully	<ul style="list-style-type: none"> <li>◆ Check if the label thickness exceeds 0.16mm (.006")</li> </ul>
When using the Cutter the labels could not feed or abnormal cutting occurs	<ul style="list-style-type: none"> <li>◆ Check if Cutter is installed properly</li> <li>◆ Check if Paper Feed Rods are sticky</li> <li>◆ Check that label is greater than 35mm (1.38") high so it can clear the Cutter</li> </ul>
The Stripper Sensor is not functioning correctly	<ul style="list-style-type: none"> <li>◆ Check if Stripper Sensor is covered with dust</li> <li>◆ Check if labels are installed properly</li> </ul>

# Appendix C. Maintenance and Adjustment

## Cleaning the Thermal Printhead



**CAUTION!**

The Printhead is the Most Fragile part of your Printer. Do NOT use sharp or hard objects to clean the Printhead. Do NOT touch the glass surface of the Printhead with your hand.



**CAUTION!**

During the print process the Printhead will become hot. Do NOT attempt to clean the Printhead until it has had time to cool.

Printing labels will cause dirt such as paper dust, particles of ink and label adhesive to accumulate on the Thermal Printhead. This can cause poor print quality and incomplete printouts. When this happens the Printhead must be cleaned:

1. Turn the Printer Off.
2. Open the Top Cover.
3. Pull the Printhead Lever out and rotate it upward to the right (counterclockwise) to open the Thermal Printhead.
4. Remove the label stock and ribbon from the Printer.
5. Clean the Printhead surface (see yellow arrow) with a special cleaning pen or a cotton swab soaked in Isopropyl Alcohol.
6. Allow the Printhead to dry for 2-3 minutes before turning the Printer back on.

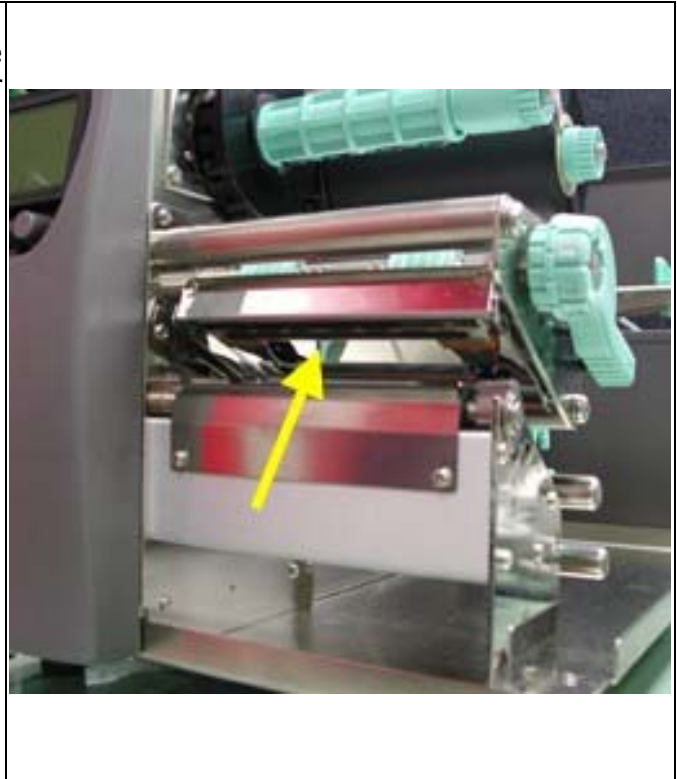

**NOTICE!**

To help keep the Printhead clean, the Top Cover of the Printer should be closed when printing. To ensure print quality and prolong Printhead life, do NOT use dusty or dirty print media in the Printer.



**NOTICE!**

Recommended cleaning intervals for the Thermal Printhead:  
Direct Thermal Printing – Each time the label roll is changed  
Thermal Transfer Printing – Each time the ribbon is changed

# Thermal Printhead Replacement

1. Switch the power off to the printer and unplug the printer.

2. Pull the Printhead Lever out and rotate it upward to the right to open the Printhead. Remove any media from the printer.



3. Gently pull the printhead assembly towards you as shown.



4. To replace the printhead, line up the plug (Fig.1) and side guides (Fig.2) of the printhead assembly and gently insert the printhead back into its carriage.

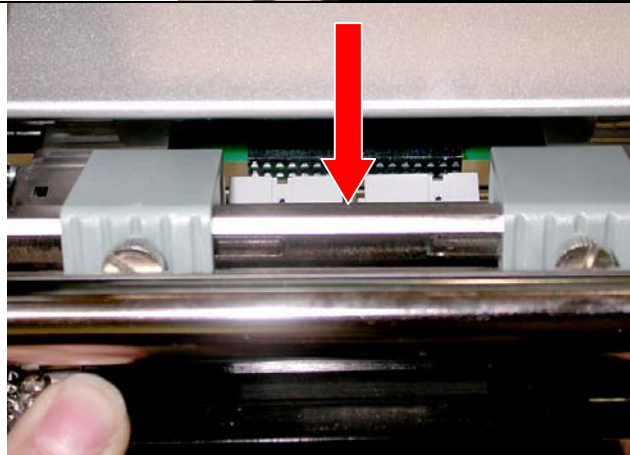

**Fig. 1**

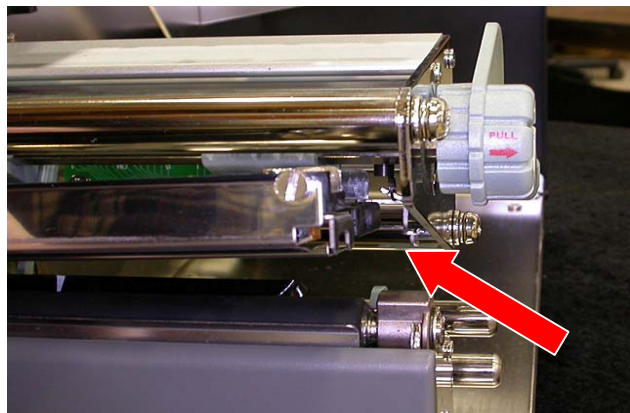
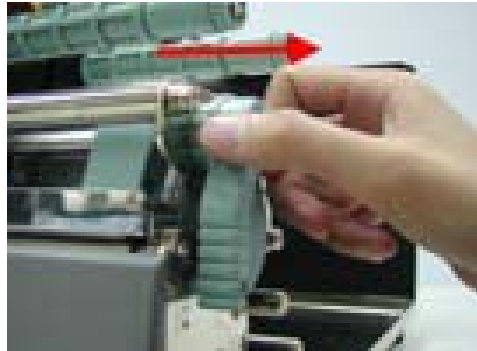

**Fig. 2**

# Thermal Printhead Print Line Adjustment

When printing on stiff or thick paper, the Print Line needs to be moved forward (paper feed direction) in order to achieve better print quality.

1. Pull the Printhead Lever out and rotate it upward to the right (counterclockwise) to open the Printhead.



2. Use a flat tip screwdriver to loosen the screws (marked A) on each side of the Printhead one full turn (as indicated by the arrows)

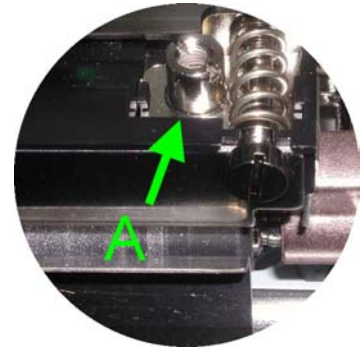
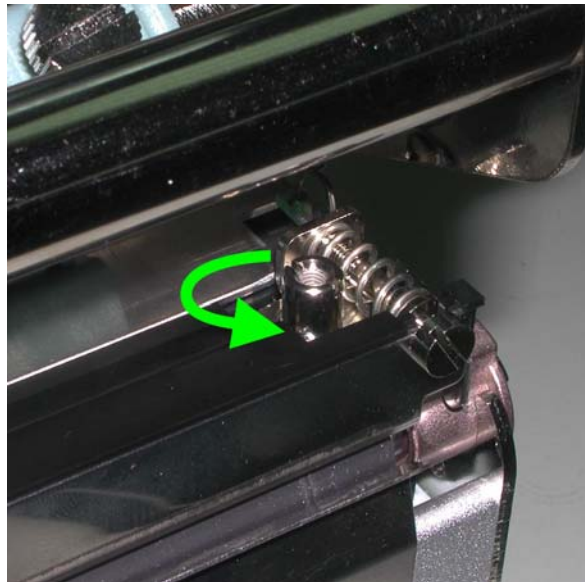

## NOTICE!

**Do NOT perform the Print Line Adjustment until the screws on each side of the Printhead (marked A) have been loosened one full turn!**

3. Move the Print Line all the way back by turning the screws on each side of the Printhead (marked B) counterclockwise

4. Then turn the screws clockwise a quarter turn at a time to move the Print Line forward. Adjust both screws by the same amount to ensure that the Print Line and the Platen Roller are parallel.

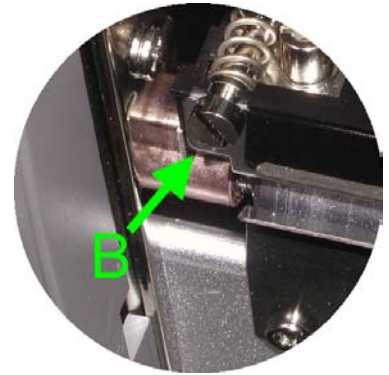
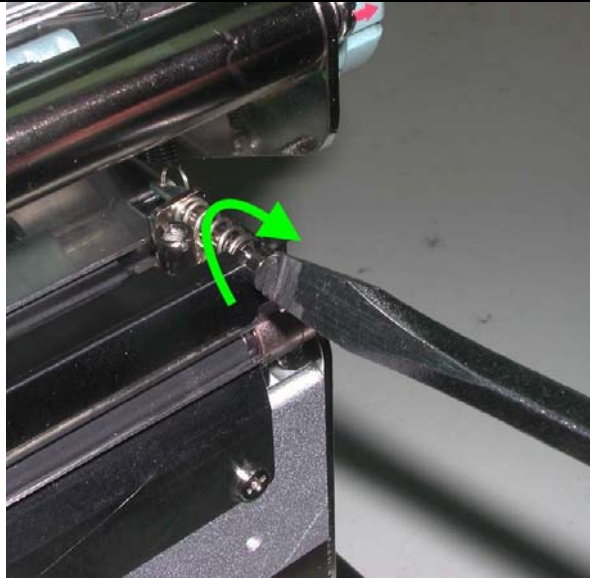

One full turn of the screws (marked B) will move the Thermal Printhead 0.5mm (.02").

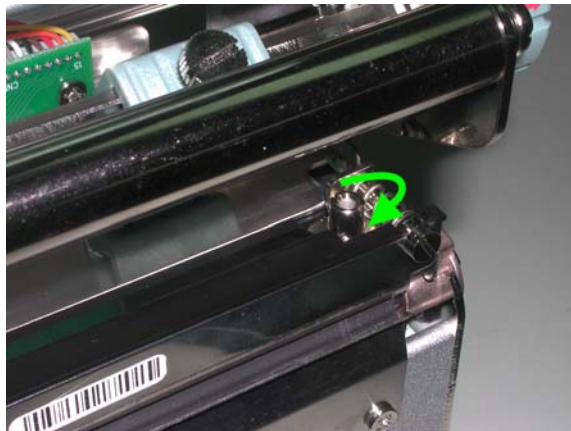

5. Once the Print Line Adjustment is completed, use a flat tip screwdriver to tighten the screws on each side of the Printhead.

6. Print a test label with a black bar across the entire width of the label to check print quality and repeat steps 4 and 5 as necessary to achieve proper print quality.

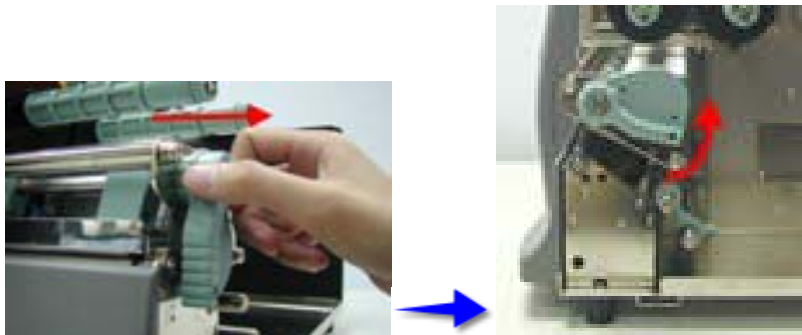
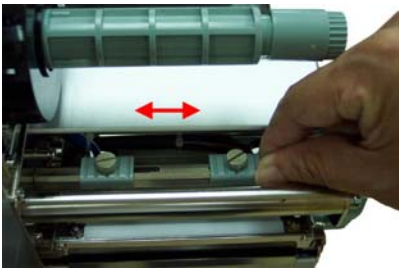

## Thermal Printhead Spring Box Position/Pressure Adjustment

If one side of the printed labels is not being printed clearly, or if ribbon wrinkles occur, then adjust the Thermal Printhead Spring Box position or pressure to cure the problem.

<p>1. Pull the Printhead Lever out and rotate it upward to the right (counterclockwise) to open the Printhead.</p>	
<p>2. Move the Thermal Printhead Spring Box on the right side. Normally, the wider the paper, the farther the Thermal Printhead Spring Box will be from the center wall and for narrower paper, the Thermal Printhead Spring Box will be closer to the center wall.</p>	
<p>3. Use a flat tip screwdriver to adjust the pressure of the Thermal Printhead Spring Box. Turn the screw clockwise to increase the pressure or counterclockwise to decrease the pressure.</p>	

## Ribbon Tension Adjustment

Due to differences in ribbon material, ribbon wrinkles may occur during printing. When this happens increase the ribbon tension by:

1. Pushing the end of the shaft in.
2. Then turn the ribbon shaft clockwise to increase the tension.

If narrower ribbons are being used (especially ribbon widths of less than 2"), the Printer might have a problem feeding labels. When this happens decrease the ribbon tension by:

1. Pushing the end of the shaft in.
2. Then turn the ribbon shaft counterclockwise to decrease the tension.

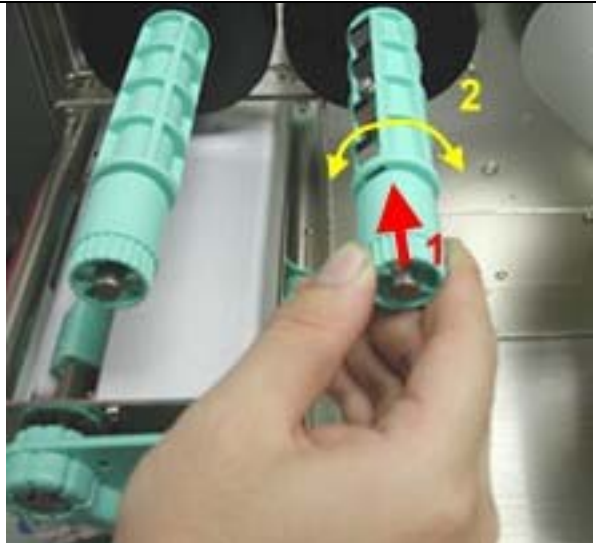

## Drive Roller Replacement

1. Switch the power off to the printer and unplug the printer.

2. Pull the Printhead Lever out and rotate it upward to the right (counterclockwise) to open the Printhead.



3. Remove all six Phillips screws (white arrows) and the c-clip (red arrow) as shown.

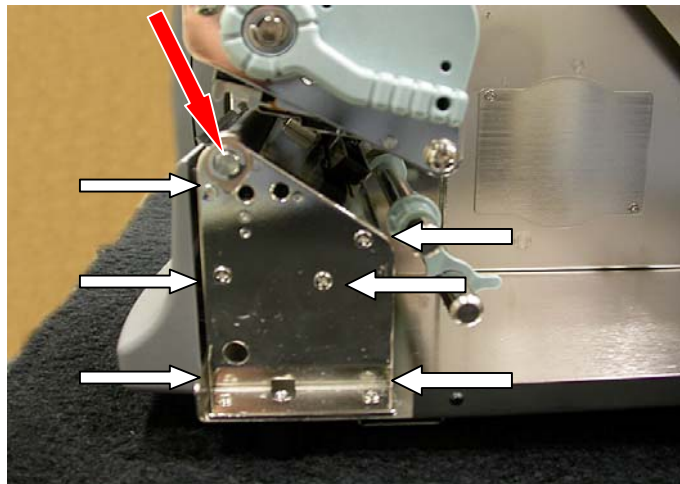

4. Remove the electronics side cover by first removing the two Phillips screws (blue arrows) and then closing the media cover. The electronics side cover can then be removed by sliding the cover straight up.

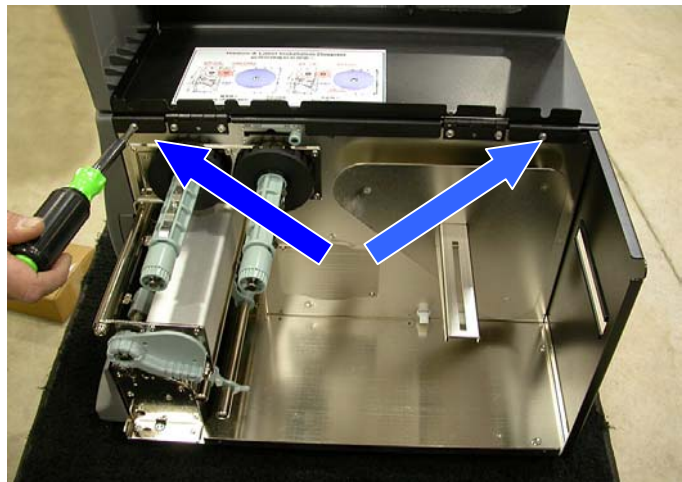

5. Remove the c-clip (orange arrow), two gears (green arrows) and two belts (yellow arrows) as shown.

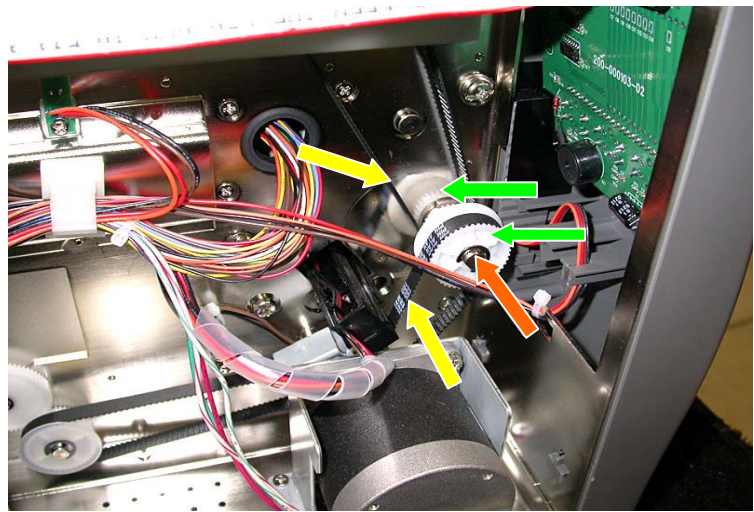

6. You may now remove the drive roller from the media side of the printer. Reverse these steps to re-install the drive roller.



## Auto Sensing

Using Auto Sensing the Printer automatically detects and records the label type and length (gap or black mark paper). Then the Printer can accurately detect the label positions.

1. Adjust the Moveable Sensor so that it is located in a position to sense the label gaps or black marks.
2. Turn the Printer Off and press and hold the Pause key.
3. Turn the Printer On while holding down the Pause key.
4. The Printer will beep 3 times and the LCD will display "Auto Sensing Mode" then release the Pause key.
5. The Printer will now detect and record the label size/length.
6. The LCD will display the measurement in dots and the Printer will go back into Standby Mode.

### NOTICE!



**Generally, the Printer should be set to Auto Mode and the Auto Sensing procedure will detect the label stock correctly. Some label stock has gaps AND black marks. This can cause the Printer to NOT correctly detect the label stock. If this happens, the Auto Sensor Option should be set to Black Mode or Gap Mode based on what you wish to base the label size on.**

## Upgrading the Printer's Firmware

The Printer's firmware can be upgraded in the field by performing the following procedure: Connect the Printer to a computer using a parallel cable. Unzip the firmware files and save them to a directory on your computer. Double-click on the file D.bat. This will open a DOS Window and start the download process. The Printer will beep once and the red error light will flash rapidly. "Program Loading" will be displayed on the Printer's LCD. When the download is complete, the red light will stop flashing, the Printer will beep twice and reset. The new firmware version will be displayed on the Printer's LCD. This confirms that the firmware has been updated.

## Clearing Cutter Jams

1. If the Cutter jams or malfunctions turn the Printer Off.
2. There is a hole (marked "A") on each side of the Cutter. Insert a 3mm hex key into one of these holes and turn the cutter blade clockwise.
3. After the problem is corrected, turn the Printer back On and the cutter blade will go back to its original position.

Note: It is recommended to use labels greater than 35mm (1.38") in height in order for them to clear the Cutter.



## Cleaning Adhesive from the Cutter Blade

When using adhesive labels, the cutter may malfunction due to a build up of adhesive on the blade. When this happens it will be necessary to clean the Cutter Blade:

1. Turn the Printer Off.
2. Remove the Cutter assembly from the printer.
3. Wet a cotton swab in Isopropyl Alcohol and use it to remove any build-ups of adhesive.
4. There is a hole (marked "A") on each side of the Cutter. Insert a 3mm hex key into one of these holes and turn the cutter blade clockwise to allow access to the entire length of the blade.
5. Allow the cutter to dry for 10 minutes.
6. Re-install the Cutter assembly and turn the Printer back On. The cutter blade will go back to its original position.

